

# BALMA, CAPODURI & C. SPA

S I N C E 1 9 2 4

CAP. SOC. € 3.600.000 INT. VERS.

Via Thomas A. Edison, 4  
27058 VOGHERA (PV) - ITALY

phone: +39 0383.212012

fax: +39 0383.41164

E-MAIL: [info@zenithbc.com](mailto:info@zenithbc.com)

[www.balmacapoduri.com](http://www.balmacapoduri.com)

C.F. – P.IVA – REG. IMP. PAVIA n° 00 17707 018 2



## PRODUCT SHEETS



*Loccovina*<sup>®</sup>



*In the field of communication Balma, Capoduri & C. spa has always paid particular attention to the realisation of leaflets, instruction sheets and catalogues which are able to clearly explain the characteristics, the functioning and the advantages offered by the **ZENITH** and **Coccinea** products.*

*The packages, made mainly using the colours that characterise our two lines - red for **ZENITH** trademark, blue for **Coccinea** - show images which are able to make the content of each box easily and immediately recognisable.*

*All packaging, from the cartons to the single boxes conceived for the points of sale, are planned and realised in a functional manner, in order to limit weights and volumes to the minimum necessary, avoiding any oversizing and at the same time guaranteeing a proper protection for the products.*

*"Sustainability", which has always been an essential and indispensable value of our business, is expressed in the social, economic and environmental fields, and is for us also synonymous with durability.*

*In fact, our products are designed and manufactured to last over time, they are tested one by one and GUARANTEED FOR LIFE... in sharp contrast to the logic of "disposable"!*

*In an era of easy relocation, the products of the **ZENITH** and **Coccinea** ranges continue to give a concrete example of what it means to be  and to be proud of it; for this reason we have decided to print on all the boxes of our products a mark clearly stating that they are really, totally and proudly Italian.*

*These product sheets are intended to communicate in a simple way the structural and technical/functional features of our products, pointing out the many advantages that our products are able to offer to an increasingly demanding end-user in terms of performance, durability and good functioning.*

*We believe that the best and deepest knowledge of our products can guarantee a decisive competitive advantage, in front of end-users who are increasingly careful to concretely verify what is "promised" by the many different offers on the market.*

march 2024

*Balma, Capoduri & C. s.p.a.*

# BALMA, CAPODURI & C. SPA

S I N C E 1 9 2 4

CAP. SOC. € 3.600.000 INT. VERS.

Via Thomas A. Edison, 4  
27058 VOGHERA (PV) - ITALY

phone: +39 0383.212012

fax: +39 0383.41164

E-MAIL: info@zenithbc.com

www.balmacapoduri.com

C.F. – P.IVA – REG. IMP. PAVIA n° 00 17707 018 2

## PRODUCT - SHEETS

### Desk staplers

“ZENITH” Ref. 500.....	pag.	1
“ZENITH” Ref. 502.....	“	2
“ZENITH” Ref. 578.....	“	3
“ZENITH” Ref. 520/E.....	“	4
“ZENITH” Ref. 520 Gold.....	“	5
“ZENITH” Ref. 522/E.....	“	6
“ZENITH” Ref. 506.....	“	7
“ZENITH” Ref. 501.....	“	8
“ZENITH” Ref. 501/E.....	“	9

### Plier staplers

“ZENITH” Ref. 548 .....	pag.	10
“ZENITH” Ref. 548 Gold.....	“	11
“ZENITH” Ref. 548/E.....	“	12
“ZENITH” Ref. 548/E TR.....	“	13
“ZENITH” Ref. 548/E Pastel .....	“	14
“ZENITH” Ref. 548/E Antibacterial .....	“	15
“ZENITH” Ref. 548/E Jeans .....	“	16
“ZENITH” Ref. 548/E Century .....	“	17
“ZENITH” desk display Ref. 548/E Pastel ESP 6.....	“	18
“ZENITH” Ref. 548/E2.....	“	19
“ZENITH” Ref. 590.....	“	20
“ZENITH” Ref. 590 MET.....	“	21
“ZENITH” Ref. 590 FUN.....	“	22
“ZENITH” Ref. 590 MIX.....	“	23
“ZENITH” Ref. 590 TECH.....	“	24
“ZENITH” Ref. 590 CRAFT.....	“	25
“ZENITH” desk display Ref. 590 TECH ESP 6.....	“	26
“ZENITH” Ref. 591.....	“	27
“ZENITH” Ref. 591 FUN.....	“	28
“ZENITH” Ref. 551.....	“	29
“ZENITH” Ref. 595.....	“	30

## **Staple-removers**

“ZENITH” Ref. 580 and 585.....	pag.	31
“ZENITH” Ref. 580 Gold e 585 Gold.....	“	32
“ZENITH” Ref. 586.....	“	33

## **Staples**

“ZENITH” (table).....	pag.	34
-----------------------	------	----

## **Corner clips**

"ZENITH" corner clips ref. 815 .....	pag.	35
"ZENITH" corner clips ref. 815 Gold.....	"	36

## **Perforators**

“ZENITH” Ref. 787.....	pag.	37
“ZENITH” Ref. 788.....	“	38
“ZENITH” Ref. 888.....	“	39
“ZENITH” Paper Drill Ref. 835.....	“	40

## **Desk accessories**

“ZENITH” Pen holder Ref. 820.....	pag.	41
“ZENITH” Clip holder Ref. 821.....	“	42
“ZENITH” Desk letter holder Ref. 825.....	“	43
“ZENITH” Letter tray Ref. 830.....	“	44

## **Glues**

“Coccoina” paste (table).....	pag.	45
“Coccoina” liquid glue (table).....	“	46
“eCoccoina” liquid glue (table).....	“	47
“Coccoina Mia” white vinyl glue (table).....	“	48
“Coccoina” stick (table).....	“	49
Can of assorted "Coccoina" glues ref. 600/C.....	“	50

## **Scented candle**

“Coccoina” art. 654.....	pag.	51
--------------------------	------	----

## **Paper products**

“Coccoina” notepads and notebooks – Vintage line (table) .....	pag.	52
“Coccoina” notepads and notebooks – Pastel line (table) .....	“	53

## **Blister packaging**

“ZENITH” (table).....	pag.	54
“Coccoina” and "Coccoina Mia" (table).....	“	55

Bar codes “ZENITH” and “Coccoina” products.....	pag.	56
---	------	----

**N.B.:** for all our “Coccoina” glues, **Safety Sheets** are available in accordance to the European regulations.

# "ZENITH" 500

## DESK STAPLER

### Materials:

- metal base and body with rubberized anti-scratch feet
- ABS anti-shock plastic cap
- lead free enamel painting highly resisting wear and corrosion

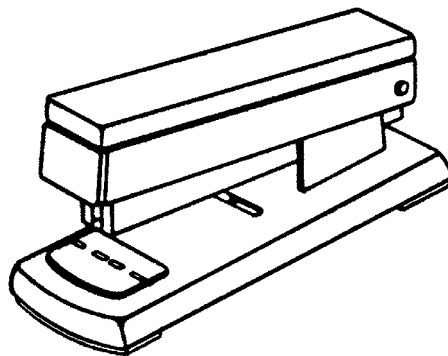

### Technical / functional features:

• <b>Stapling:</b>		
• <b>Staple type:</b>	24/6 - 24/8	26/6 - 26/8
• <b>ZENITH staple ref.:</b>	515-115	512-112
• <b>Loading capacity (N° of staples):</b>	100	150
• <b>Stapling capacity (N° of sheets - 80 g/sqm):</b>	20 (24/6 - 26/6 staples)	35 (24/8 - 26/8 staples)

- **Max. stapling depth (for paper insertion):** 70 mm

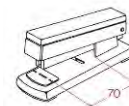

• <b>Colours:</b>	BLACK - GREY
• <b>Packaging:</b>	box containing a stapler and a box of "ZENITH" staples ref. 515
• <b>Box dimensions:</b>	15 x 6,7 x 6,5 cm
• <b>Weight:</b>	335 g (net) / 425 g (gross, including a box of "ZENITH" staples ref. 515)
• <b>N° of items per carton:</b>	60 (packets of 5 pieces)
• <b>Carton dimensions:</b>	47 x 38 x 35 cm (AxBxC)
• <b>Carton weight:</b>	25,5 Kg

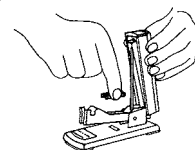
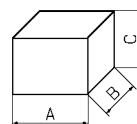

**Loading system:** top loading; pull-up the cap and insert staples

**Patented anti-jamming device.**

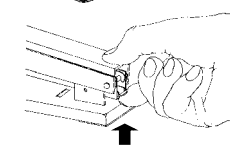

### Descriptive notes:

"ZENITH" 500 offers good performance with respect to stapling capacity and depth so that it is perfectly suitable for any kind of office work.

**Quality:** to maintain the high quality standard guaranteed by all "ZENITH" products, each stapler is tested piece by piece. **Life-Guarantee for manufacturing defects.**

**In addition:** "ZENITH" 500 is light and easy to use because of its practical top loading system and is perfect for all stapling requirements. It offers the possibility to staple in three different ways and it can also be used as a tacker.

# "ZENITH" 502

## DESK STAPLER

### Materials:

- metal base and body
- anti-scratch rubber base pad
- ABS anti-shock plastic cap
- lead free enamel painting highly resisting wear and corrosion

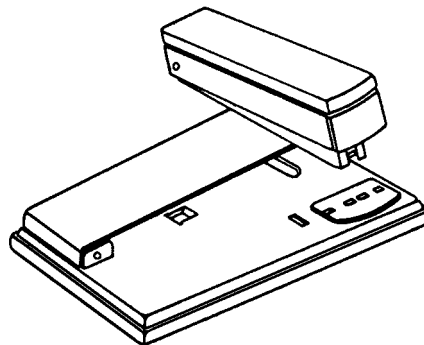

### Technical / functional features:

- **Stapling:**



- **Staple type:**

24/6 - 24/8

26/6 - 26/8

- **"ZENITH" staple ref.:**

515-115

512-112

- **Loading capacity (N° of staples):**

100

150

- **Stapling capacity (N° of sheets - 80 g/sqm):**

20

35

(24/6 - 26/6 staples)

(24/8 - 26/8 staples)

- **Max. stapling depth (for paper insertion):**

108 mm



- **Colours:**

BLACK - GREY

- **Packaging:**

box containing a stapler and a box of "ZENITH" staples ref. 515

- **Box dimensions:**

16,5 x 14,5 x 7,5 cm

- **Weight:**

530 g (net) / 660 g (gross, including a box of "ZENITH" staples ref. 515)

- **N° of items per carton:**

30 (packets of 2 pieces)

- **Carton dimensions:** 47 x 38 x 35 cm (AxBxC)

- **Carton weight:** 20 Kg

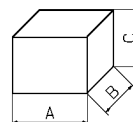

**Loading system:** top loading; pull-up the cap and insert staples

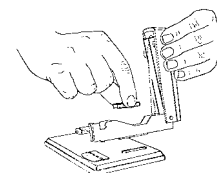

**Patented anti-jamming device.**

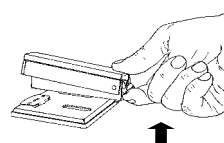

### Descriptive notes:

"ZENITH" 502 gives the same, good performance of the "ZENITH" 500 and is perfect for any kind of office work.

**Quality:** to maintain the high quality standard guaranteed by all "ZENITH" products, each stapler is tested piece by piece. **Life-Guarantee for manufacturing defects.**

**In addition:** as a result of its great stapling depth of 108 mm, the "ZENITH" 502 can staple precisely along the fold of the sheets (even for large-sized sheets - see picture); therefore, it is practical and handy to use for pamphlets, booklets etc.

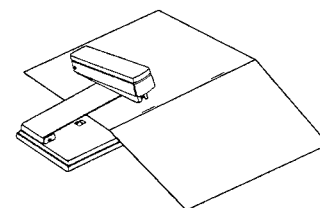

# "ZENITH" 578

## DESK STAPLER

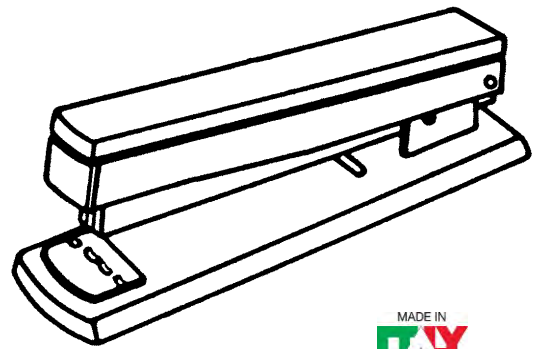

### Materials:

- metal base and body with rubberized anti-scratch feet
- ABS anti-shock plastic cap
- lead free enamel painting highly resisting wear and corrosion

### Technical / functional features:

• <b>Stapling:</b>		
• <b>Staple type:</b>	24/6 - 24/8	26/6 - 26/8
• <b>"ZENITH" staple ref.:</b>	515-115	512-112
• <b>Loading capacity (N° of staples):</b>	200	250
• <b>Stapling capacity (N° of sheets - 80 g/sqm):</b>	20 (24/6 - 26/6 staples)	35 (24/8 - 26/8 staples)

- **Max. stapling depth (for paper insertion):** 130 mm

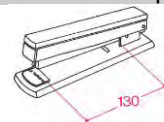

• <b>Colours:</b>	BLACK - GREY
• <b>Packaging:</b>	box containing a stapler and a box of "ZENITH" staples ref. 515
• <b>Box dimensions:</b>	21 x 6,4 x 6,6 cm
• <b>Weight:</b>	445 g (net) / 540 g (gross, including a box of "ZENITH" staples ref. 515)
• <b>N° of items per carton:</b>	30 (packets of 3 pieces)
• <b>Carton dimensions:</b>	43,5 x 36 x 27 cm (AxBxC)
• <b>Carton weight:</b>	17 Kg

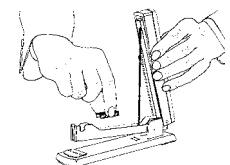
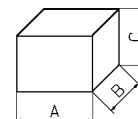

**Loading system:** top loading; pull-up the cap and insert staples

**Patented anti-jamming device.**

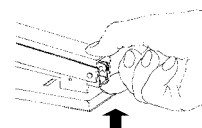

### Descriptive notes:

Technically efficient and aesthetically pleasing, "ZENITH" 578 offers excellent performance, particularly with respect to the capacity and stapling depth.

**Quality:** to maintain the high quality standard guaranteed by all "ZENITH" products, each stapler is tested piece by piece. **Life-Guarantee for manufacturing defects.**

**In addition:** as a result of its exceptional loading capacity (up to 250 26/6 and 26/8 staples), "ZENITH" 578 is an inexhaustible stapler; the great stapling depth of 130 mm makes "ZENITH" 578 suitable for all stapling needs. It can also be used as a tacker.

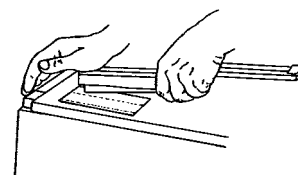

# "ZENITH" 520/E

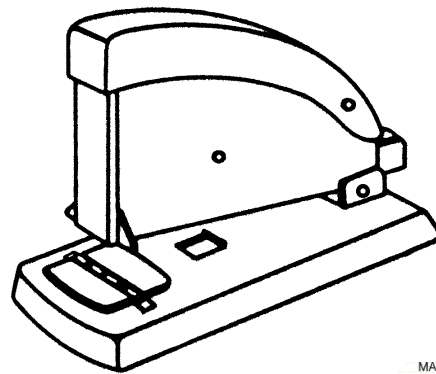

## DESK STAPLER



### Materials:

- made entirely in metal
- lead free enamel painting highly resisting wear and corrosion

### Technical / functional features:

• <b>Stapling:</b>			
• <b>Staple type:</b>	24/6	24/8	24/10
• <b>"ZENITH" staple ref.:</b>	515 - 115		
• <b>Loading capacity (N° of staples):</b>	50		
• <b>Stapling capacity (N° of sheets - 80 g/sqm):</b>	20	35	40
• <b>Max. stapling depth (for paper insertion):</b>	70 mm		
• <b>Colour:</b>	ALUMINIUM		
• <b>Packaging:</b>	box containing a stapler and a box of "ZENITH" staples ref. 515		
• <b>Box dimensions:</b>	12 x 6,3 x 9,4 cm		
• <b>Weight:</b>	290 g (net) / 380 g (gross, including a box of "ZENITH" staples ref. 515)		
• <b>N° of items per carton:</b>	60 (packets of 5 pieces)		
• <b>Carton dimensions:</b>	47 x 38 x 35 cm (AxBxC)		
• <b>Carton weight:</b>	23,5 Kg		

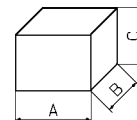

**Loading system:** rear loading, with extractable pusher

**Patented anti-jamming device.**

### Descriptive notes:

"ZENITH" 520/E is a strong stapler with simple but smartly rounded lines; it uses the traditional rear loading system with extractable pusher.

**Quality:** to maintain the high quality standard guaranteed by all "ZENITH" products, each stapler is tested piece by piece. ***Life-Guarantee for manufacturing defects.***

**In addition:** "ZENITH" 520/E as well as offering the possibility of stapling in three different ways to satisfy all user's needs, it can also use the 24/10 staples (length of the legs 10 mm) to staple easily up to 40 sheets!





# "ZENITH" 520 GOLD DESK STAPLER



## Materials:

- made entirely in painted metal with gold-plated parts (23 carats)
- lead free enamel painting highly resisting wear and corrosion

## Technical / functional features:

• Stapling:			
• Staple type:	24/6	24/8	24/10
• "ZENITH" staple ref.:	515 - 115		
• Loading capacity (N° of staples):	50		
• Stapling capacity (N° of sheets - 80 g/sqm):	20	35	40
• Max. stapling depth (for paper insertion):	70 mm		
• Colour:	RED /GOLD - BLACK / GOLD		
• Packaging:	slipcase containing a stapler and a box of "ZENITH" staples ref. 115/Z		
• Slipcase dimensions:	12,8 x 7 x 11 cm		
• Weight:	292 g (net) / 420 g (gross, including a box of "ZENITH" staples ref. 115/Z)		

**Loading system:** rear loading, with extractable pusher

**Patented anti-jamming device.**

## Descriptive notes:

Some parts of ZENITH 520 GOLD get "clothed" with gold: this is what distinguishes and makes this special edition unique, in addition to its elegant rounded lines and an exclusive slipcase packaging.

**Quality:** to maintain the high quality standard guaranteed by all "ZENITH" products, each stapler is tested piece by piece. ***Life-Guarantee for manufacturing defects.***

**In addition:** "ZENITH" 520 GOLD as well as offering the possibility of stapling in three different ways to satisfy all user's needs, it can also use the 24/10 staples (length of the legs 10 mm) to staple easily up to 40 sheets!

# "ZENITH" 522/E

## DESK STAPLER

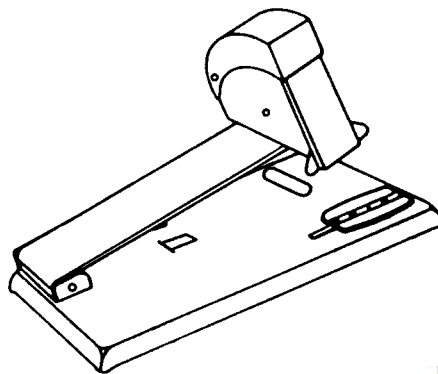

### Materials:

- made entirely in metal
- lead free enamel painting highly resisting wear and corrosion

### Technical / functional features:

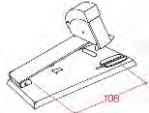
• Stapling:			
• Staple type:	24/6	24/8	24/10
• "ZENITH" staple ref.:	515-115		
• Loading capacity (N° of staples):	50		
• Stapling capacity (N° of sheets - 80 g/sqm):	20	35	40
• Max. stapling depth (for paper insertion):	108 mm		
• Colour:	ALUMINIUM		
• Packaging:	box containing a stapler and a box of "ZENITH" staples ref. 515		
• Box dimensions:	16,6 x 11,7 x 10 cm		
• Weight:	535 g (net) / 655 g (gross, including a box of "ZENITH" staples ref. 515)		
• N° of items per carton:	30 (packets of 3 pieces)		
• Carton dimensions:	47,5 x 38 x 39,5 cm (AxBxC)		
• Carton weight:	20,5 Kg		

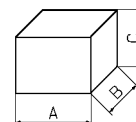

Loading system: rear loading, with extractable pusher

Patented anti-jamming device.

### Descriptive notes:

"ZENITH" 522/E is a strong stapler with simple but smartly rounded lines; it uses the traditional rear loading system with extractable pusher.

**Quality:** to maintain the high quality standard guaranteed by all "ZENITH" products, each stapler is tested piece by piece. **Life-Guarantee for manufacturing defects.**

**In addition:** as well as offering the possibility to staple up to 40 sheets using 24/10 staples, the "ZENITH" 522/E can staple folded sheets such as those found in a copy book (see picture) because of its great stapling depth. Therefore, it is easy and handy to use for pamphlets, booklets etc.

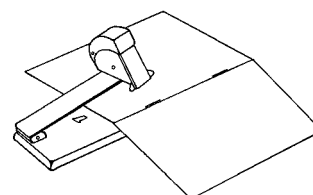

# "ZENITH" 506

## LONG-ARM STAPLER

### Materials:

- metal base and body with rubberized anti-scratch feet
- ABS anti-shock plastic cap
- lead free enamel painting highly resisting wear and corrosion

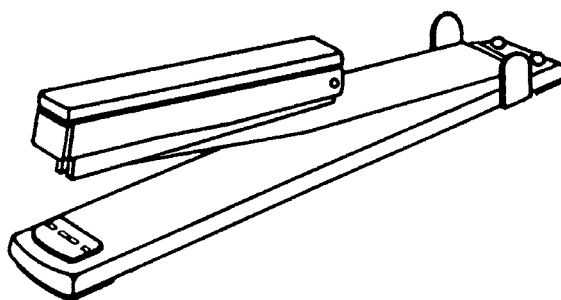

### Technical / functional features:

• <b>Stapling:</b>		
• <b>Staple type:</b>	24/6 - 24/8	26/6 - 26/8
• <b>"ZENITH" staple ref.:</b>	515-115	512-112
• <b>Loading capacity (N° of staples):</b>	200	250
• <b>Stapling capacity (N° of sheets - 80 g/sqm):</b>	20 (24/6 - 26/6 staples)	35 (24/8 - 26/8 staples)

- **Max. stapling depth (for paper insertion):** 305 mm

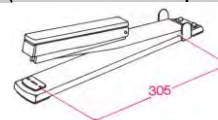

• <b>Colour:</b>	BLACK
• <b>Packaging:</b>	box containing a stapler and a box of "ZENITH" staples ref. 515
• <b>Box dimensions:</b>	37,5 x 6,5 x 6,5 cm
• <b>Weight:</b>	680 g (net) / 795 g (gross, including a box of "ZENITH" staples ref. 515)
• <b>N° of items per carton:</b>	30
• <b>Carton dimensions:</b>	47,5 x 38 x 39,5 cm (AxBxC)
• <b>Carton weight:</b>	25 Kg

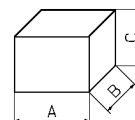

**Loading system:** top loading; pull-up the cap and insert staples

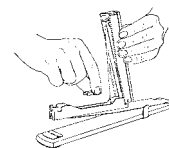

**Patented anti-jamming device.**

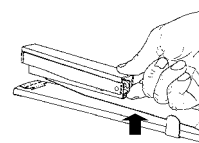

### Descriptive notes:

As a result of its exceptional stapling depth, the "ZENITH" 506 long-arm stapler is suitable for any use even beyond the normal range of office work.

**Quality:** to maintain the high quality standard guaranteed by all "ZENITH" products, each stapler is tested piece by piece. **Life-Guarantee for manufacturing defects.**

**In addition:** "ZENITH" 506 can also be used for particular work which requires consistent precision, for example, sample books, boxes and so on. To ensure the best precision, "ZENITH" 506 has a slider on a millimetre guide under the base.

# "ZENITH" 501

## DESK STAPLER

### Materials:

- metal body and mechanical parts
- anti-sliding rubber base
- ABS anti-shock cap

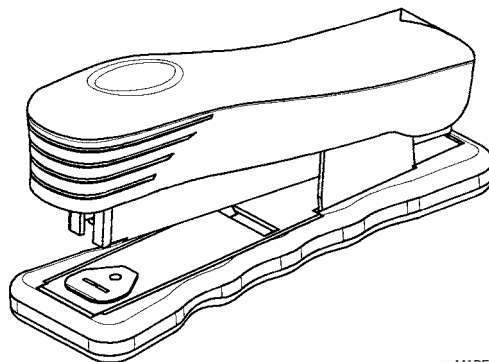

### Technical / functional features:

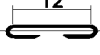
• Stapling:		
• Staple type:	24/6	26/6
• "ZENITH" staple ref.:	515-115	512-112
• Loading capacity (N° of staples):	100	150
• Stapling capacity (N° of sheets - 80 g/sqm):	20 (24/6 - 26/6 staples)	

- Max. stapling depth (for paper insertion): 70 mm



- Colours: Black - Red - Green  
Transparent Red – Transparent Blue - Transparent Yellow

- Packaging: box containing a stapler and a box of "ZENITH" staples ref. 112/Z

- Box dimensions: 14,5 x 5,3 x 6,7 cm

- Weight: 259 g (net) / 345 g (gross, including a box of "ZENITH" staples ref. 112/Z)

- N° of items per carton: 60 (packets of 3 pieces)

- Carton dimensions: 48 x 26,5 x 35,5 cm (AxBxC)

- Carton weight: 21,5 Kg

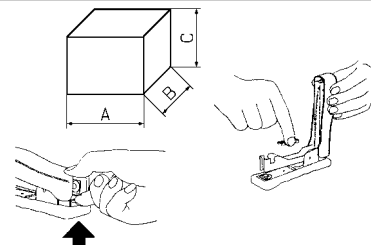

**Loading system:** top loading; pull-up the cap and insert staples

**Patented anti-jamming device.**

**Descriptive notes:** "ZENITH" ref. 501 combines the best features of the whole range of "ZENITH" staplers: reliability, precision, strength, elegance, easy loading system, sweet stapling.

**Quality:** to maintain the high quality standard guaranteed by all "ZENITH" products, each stapler is tested piece by piece. **Life-Guarantee for manufacturing defects.**

**In addition:** it may be used as desk-stapler but also, with equal comfort, as a plier-stapler, thanks to its well designed dimensions, the refined ergonomics of the base and to the short distance between the base and the upper surface of the cap. The colours choice is wide: black, red, green, transparent red, transparent blue, transparent yellow cap combined with the grey base.

It is available in two packages to allow the best display at every point of sale: box version supplied with 1500 "ZENITH" staples ref. 112/Z (26/6) in zincplated wire and double-valve blister (named "Shell") supplied with 1000 "ZENITH" "MIL" staples ref. 515 (24/6) in natural wire.

It can also be used as a tacker.

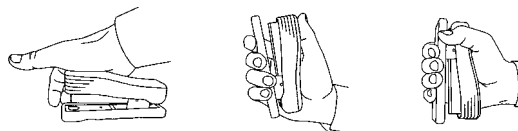

# "ZENITH" 501/E

## DESK STAPLER

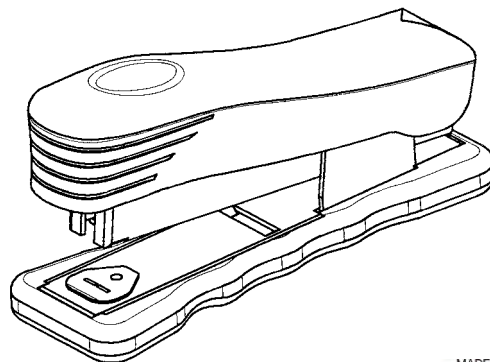

### Materials:

- metal body and mechanical parts
- lead free enamel painting highly resisting wear and corrosion
- anti-sliding rubber base
- ABS anti-shock cap

### Technical / functional features:

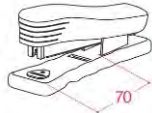
• Stapling:		
• Staple type:	24/6	26/6
• "ZENITH" staple ref.:	515-115	512-112
• Loading capacity (N° of staples):	100	150
• Stapling capacity (N° of sheets - 80 g/sqm):	20 (24/6 - 26/6 staples)	
• Max. stapling depth (for paper insertion):	70 mm	
• Colours:	BLACK	
• Packaging:	box (without staples)	
• Box dimensions:	14,5 x 4,8 x 6,5 cm	
• Weight:	259 g (net) / 275 g (gross)	
• N° of items per carton:	60 (packets of 3 pieces)	
• Carton dimensions:	48 x 26,5 x 35,5 cm (AxBxC)	
• Carton weight:	17,5 Kg	

**Loading system:** top loading; pull-up the cap and insert staples

**Patented anti-jamming device.**

**Descriptive notes:** "ZENITH" ref. 501/E has the same features of ref. 501: reliability, precision, strength, elegance, easy loading system, smooth stapling. The only difference if compared to ref. 501 is the painting in aluminium colour of the metal parts. Available in black colour only.

**Quality:** to maintain the high quality standard guaranteed by all "ZENITH" products, each stapler is tested piece by piece. **Life-Guarantee for manufacturing defects.**

**In addition:** it may be used as desk-stapler but also, with equal comfort, as a plier-stapler, thanks to its well designed dimensions, the refined ergonomics of the base and to the short distance between the base and the upper surface of the cap.

It can also be used as a tacker.

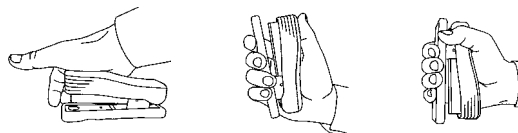

# "ZENITH" 548

## PLIER STAPLER

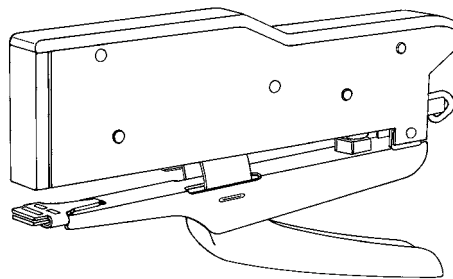

### Materials:

- made in painted metal with parts in nickel-plated brass
- lead free enamel painting highly resisting wear and corrosion



### Technical / functional features:

- **Stapling:**



- **Staple type:**

6/4

6/6

- **"ZENITH" staple ref.:**

130/E - 130/Z  
130/LM - 130/LL

130/Z 6

- **Loading capacity (N° of staples):**

100

100

- **Stapling capacity (N° of sheets - 80 g/sqm):**

15

30

- **Max. stapling depth (for paper insertion):**

47 mm

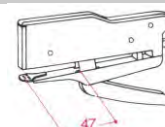

- **Colours:**

BLACK - WHITE - RED BORDEAUX - BLUE

- **Packaging:**

box containing a stapler and a box of "ZENITH" staples ref. 130/Z

- **Box dimensions:**

16,5 x 10,6 x 2,7 cm

- **Weight:**

245 g (net) / 310 g (gross, including a box of "ZENITH" staples ref. 130/Z)

- **N° of items per carton:**

60 (packets of 5 pieces)

- **Carton dimensions:** 35 x 36 x 29,5 cm (AxBxC)

- **Carton weight:** 19 Kg

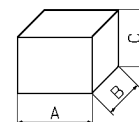

**Loading system:** rear loading, with extractable pusher

**Patented anti-jamming device.**

The plier directions are on the back of the packaging.

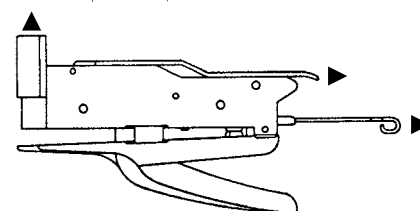

### Descriptive notes:

"ZENITH" 548 is remarkable for its technical and aesthetical perfection and it is a nice and functional work tool.

**Quality:** to maintain the high quality standard guaranteed by all "ZENITH" products, each plier stapler is tested piece by piece. **Life-Guarantee for manufacturing defects.**

**In addition:** features like its fine accuracy, finishing, painting in four smart colours and the possibility to choose between permanent or temporary stapling, make "ZENITH" 548 the top plier stapler of the "ZENITH" family.

"ZENITH" 548 can also staple with the "ZENITH" staples ref. 130/Z6 (length of legs 6 mm) up to 30 sheets!

# "ZENITH" 548 Gold

## PLIER STAPLER

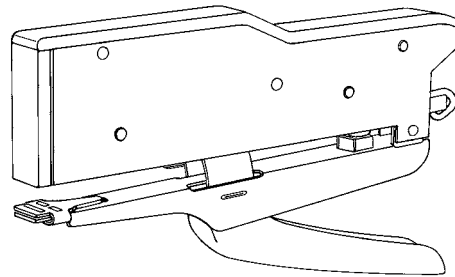

### Materials:

- made in painted metal with parts in gold-plated brass (23 carats)
- lead free enamel painting highly resisting wear and corrosion

### Technical / functional features:

- **Stapling:**



- **Staple type:**

6/4

6/6

- **"ZENITH" staple ref.:**

130/E - 130/Z  
130/LM - 130/LL

130/Z 6

- **Loading capacity (N° of staples):**

100

100

- **Stapling capacity (N° of sheets - 80 g/sqm):**

15

30

- **Max. stapling depth (for paper insertion):**

47 mm

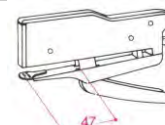

- **Colours:**

RED / GOLD - BLACK / GOLD

- **Packaging:**

box containing a stapler and  
a box of "ZENITH" staples ref. 130/Z

- **Box dimensions:**

22,5 x 16,5 x 2 cm

- **Weight:**

245 g (net) / 400 g (gross, including a box of  
"ZENITH" staples ref. 130/Z)

**Loading system:** rear loading, with extractable pusher

**Patented anti-jamming device.**

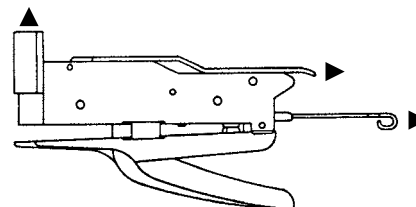

The **plier directions** are included in the packaging.

### Descriptive notes:

"ZENITH" 548 Gold in addition to offering high quality, practicality and elegance common to the whole range of "ZENITH" plier staplers, has an extraordinary finish. In fact, the body is painted with a shiny orange-red colour or in an elegant black colour and the other external components are finely finished with gold-plated brass.

**Quality:** to maintain the high quality standard guaranteed by all "ZENITH" products, each plier stapler is tested piece by piece. **Life-Guarantee for manufacturing defects.**

**In addition:** with the beauty of the stapler and the smart packaging "ZENITH" 548 Gold can also offer a nice business or personal gift for those who like to organize their work, at home or in the office, with an extra touch of class.

"ZENITH" 548 Gold can also staple with the "ZENITH" staples ref. 130/Z6 (length of legs 6 mm) up to 30 sheets!



# "ZENITH" 548/E

## PLIER STAPLER

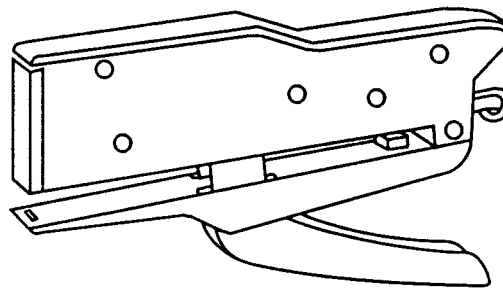

### Materials:

- made entirely in painted metal with nickel-plated finishing
- lead free enamel painting highly resisting wear and corrosion

### Technical / functional features:

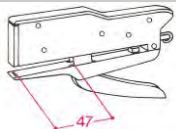
• <b>Stapling:</b>		
• <b>Staple type:</b>	6/4	6/6
• <b>"ZENITH" staple ref.:</b>	130/E - 130/Z 130/LM - 130/LL	130/Z 6
• <b>Loading capacity (N° of staples):</b>	100	100
• <b>Stapling capacity (N° of sheets - 80 g/sqm):</b>	15	30
• <b>Max. stapling depth (for paper insertion):</b>	47 mm	
• <b>Colours:</b>	GREY - ALUMINIUM - GREEN/BLACK - BLUE/PALE BLUE - RED/BLACK	
• <b>Packaging:</b>	box containing a stapler and a box of "ZENITH" staples ref. 130/E	
• <b>Box dimensions:</b>	15,4 x 8,7 x 1,6 cm	
• <b>Weight:</b>	240 g (net) / 285 g (gross, including a box of "ZENITH" staples ref. 130/E)	
• <b>N° of items per carton:</b>	60 (packets of 10 pieces)	
• <b>Carton dimensions:</b>	32,5 x 27 x 21 cm (AxBxC)	
• <b>Carton weight:</b>	17,5 Kg	

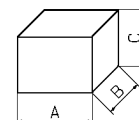

**Loading system:** rear loading, with extractable pusher

**Patented anti-jamming device.**

The plier directions are on the back of the packaging.

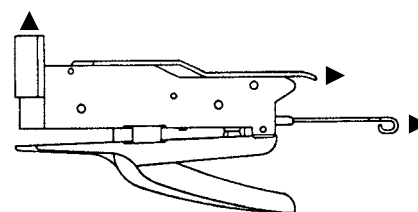

### Descriptive notes:

As a leader, "ZENITH" 548/E is used every day by millions of users who are satisfied with its quality, practicality, strength and endless capacity to function, even after years of continuous use.

**Quality:** to maintain the high quality standard guaranteed by all "ZENITH" products, each plier stapler is tested piece by piece. ***Life-Guarantee for manufacturing defects.***

**In addition:** "ZENITH" 548/E has been improved over the years through many technical innovations unknown to the end user but useful to enhance its already envious perfection. Today it is offered in five nice colour combinations to meet the tastes of every customer.

"ZENITH" 548/E can also staple with the "ZENITH" staples ref. 130/Z6 (length of legs 6 mm) up to 30 sheets!



# "ZENITH" 548/E TR Tricolour

## PLIER STAPLER

### Materials:

- made entirely in painted metal with nickel-plated finishing
- lead free enamel painting highly resisting wear and corrosion

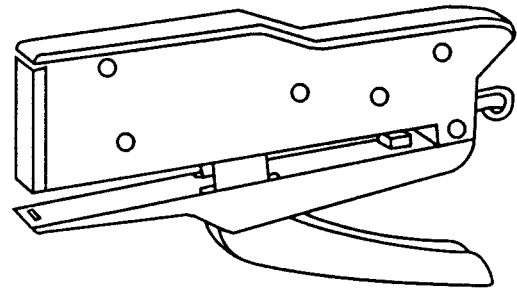

### Technical / functional features:

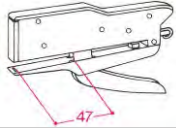
• <b>Stapling:</b>		
• <b>Staple type:</b>	6/4	6/6
• <b>"ZENITH" staple ref.:</b>	130/E - 130/Z 130/LM - 130/LL	130/Z 6
• <b>Loading capacity (N° of staples):</b>	100	100
• <b>Stapling capacity (N° of sheets - 80 g/sqm):</b>	15	30
• <b>Max. stapling depth (for paper insertion):</b>	47 mm	
• <b>Colours:</b>	TRICOLOUR (colours of the Italian flag)	
• <b>Packaging:</b>	box containing a stapler and a box of "ZENITH" staples ref. 130/E	
• <b>Box dimensions:</b>	15,4 x 8,7 x 1,6 cm	
• <b>Weight:</b>	240 g (net) / 285 g (gross, including a box of "ZENITH" staples ref. 130/E)	
• <b>N° of items per carton:</b>	60 (packets of 10 pieces)	
• <b>Carton dimensions:</b>	32,5 x 27 x 21 cm (AxBxC)	
• <b>Carton weight:</b>	17,5 Kg	

**Loading system:** rear loading, with extractable pusher

**Patented anti-jamming device.**

The plier directions are on the back of the packaging.

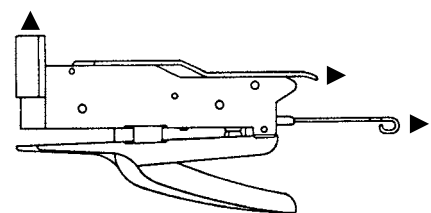

### Descriptive notes:

The tricolour version of "ZENITH" stapler ref. 548/E wears the colours of the Italian flag and is available in a packaging specially realised.

The technical and functional characteristics are the same as in "ZENITH" stapler ref. 548/E, leader in the office and used everyday by millions of affectionate Customers.

**Quality:** to maintain the high quality standard guaranteed by all "ZENITH" products, each plier stapler is tested piece by piece. **Life-Guarantee for manufacturing defects.**

**In addition:** "ZENITH" 548/E has been improved over the years through many technical innovations unknown to the end user but useful to enhance its already enviable perfection. Today it is offered in five nice colour combinations to meet the tastes of every customer.

"ZENITH" 548/E TR can also staple with the "ZENITH" staples ref. 130/Z6 (length of legs 6 mm) up to 30 sheets!

# "ZENITH" 548/E

PLIER STAPLER

Pastel

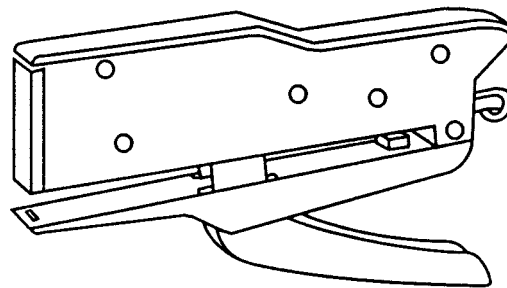

## Materials:

- made entirely in painted metal with nickel-plated finishing
- lead free enamel painting highly resisting wear and corrosion



## Technical / functional features:

• Stapling:		
• Staple type:	6/4	6/6
• "ZENITH" staple ref.:	130/E - 130/Z 130/LM - 130/LL	130/Z 6
• Loading capacity (N° of staples):	100	100
• Stapling capacity (N° of sheets - 80 g/sqm):	15	30

- Max. stapling depth (for paper insertion): 47 mm

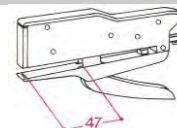

- Colours: PINK – YELLOW – LIGHT BLUE

- Packaging: box containing a stapler and a box of "ZENITH" staples ref. 130/E

- Box dimensions: 15,4 x 8,7 x 1,6 cm

- Weight: 240 g (net) / 285 g (gross, including a box of "ZENITH" staples ref. 130/E)

- N° of items per carton: 60 (packets of 10 pieces)

- Carton dimensions: 32,5 x 27 x 21 cm (AxBxC)

- Carton weight: 17,5 Kg

**Loading system:** rear loading, with extractable pusher

**Patented anti-jamming device.**

The plier directions are on the back of the packaging.

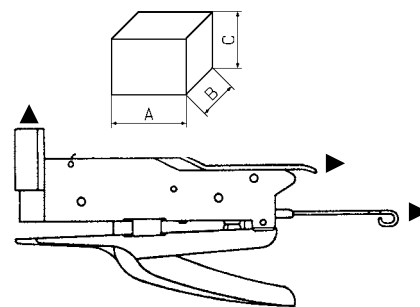

## Descriptive notes:

The Pastel version of the "ZENITH" stapler ref. 548/E is available in three modern nuances of colour combinations, i.e. pink, yellow and light blue, in new boxes specially realised. These are scarcely saturated, non-metallic colours, that evoke the pastel hues of the 1950s, with a "super-matt" finish that conveys a "velvet-feel".

The technical and functional characteristics are the same as for the "ZENITH" stapler ref. 548/E.

For the introduction in the point of sale, there is also a small and practical desk display, ref. 548/E Pastel ESP 6, containing six staplers assorted in the three colours.

**Quality:** to maintain the high quality standard guaranteed by all "ZENITH" products, each plier stapler is tested piece by piece. **Life-Guarantee for manufacturing defects.**

**In addition:** "ZENITH" 548/E has been improved over the years through many technical innovations unknown to the end user but useful to enhance its already envious perfection. Today it is offered in five nice colour combinations to meet the tastes of every customer.

"ZENITH" 548/E Pastel can also staple with the "ZENITH" staples ref. 130/Z6 (length of legs 6 mm) up to 30 sheets!

# "ZENITH" 548/E Antibacterial

## PLIER STAPLER

### Materials:

- made entirely in painted metal with nickel-plated finishing
- lead free and cadmium-free enamel painting highly resisting wear and corrosion and with highly functional additive for releasing silver ions

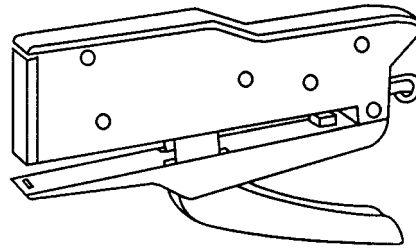

### Technical / functional features:

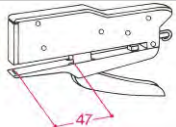
• <b>Stapling:</b>		
• <b>Staple type:</b>	6/4	6/6
• <b>"ZENITH" staple ref.:</b>	130/E - 130/Z 130/LM - 130/LL	130/Z 6
• <b>Loading capacity (N° of staples):</b>	100	100
• <b>Stapling capacity (N° of sheets - 80 g/sqm):</b>	15	30
• <b>Max. stapling depth (for paper insertion):</b>	47 mm	
• <b>Colour:</b>	DEWY GREEN	
• <b>Packaging:</b>	box containing a stapler and a box of "ZENITH" staples ref. 130/E	
• <b>Box dimensions:</b>	15,4 x 8,7 x 1,6 cm	
• <b>Weight:</b>	240 g (net) / 285 g (gross, including a box of "ZENITH" staples ref. 130/E)	
• <b>N° of items per carton:</b>	60 (packets of 10 pieces)	
• <b>Carton dimensions:</b>	32,5 x 27 x 21 cm (AxBxC)	
• <b>Carton weight:</b>	17,5 Kg	

**Loading system:** rear loading, with extractable pusher

### Patented anti-jamming device.

The plier directions are on the back of the packaging.

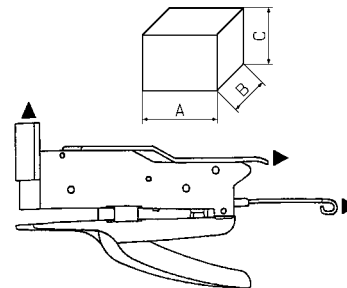

### Descriptive notes:

"ZENITH" stapler 548/E Antibacterial maintains all the technical and functional characteristics of the 548/E "ZENITH" stapler, leader in the office and used every day by millions of users who are satisfied with its quality, practicality, strength and endless capacity to function, even after years of continuous use. The special additive for releasing highly functional silver ions allows the formation of a protective film on the whole stapler, which is resistant to attacks by strains of **Gram-negative** and **Gram-positive bacteria** such as **Escherichia Coli** and **Staphilococcus Aureus**.

**Quality:** to maintain the high quality standard guaranteed by all "ZENITH" products, each plier stapler is tested piece by piece. **Life-Guarantee for manufacturing defects.**

**In addition:** The very high antibacterial resistance, evaluated according to ISO 22196 - 2011, does not interfere with the performances of the stapler, which is therefore suitable to be used in environments that require specific prevention and resistance to bacterial proliferation.

"ZENITH" 548/E Antibacterial can also staple with the "ZENITH" staples ref. 130/Z6 (length of legs 6 mm) up to 30 sheets!

# "ZENITH" 548/E PLIER STAPLER JEANS

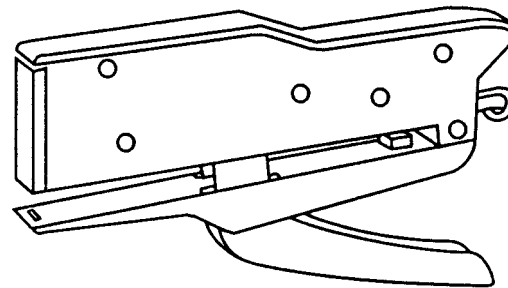

## Materials:

- made entirely in painted metal with nickel-plated finishing
- lead free enamel painting highly resisting wear and corrosion, applied with a special procedure



## Technical / functional features:

• <b>Stapling:</b>		
• <b>Staple type:</b>	6/4	6/6
• <b>"ZENITH" staple ref.:</b>	130/E - 130/Z 130/LM - 130/LL	130/Z 6
• <b>Loading capacity (N° of staples):</b>	100	100
• <b>Stapling capacity (N° of sheets - 80 g/sqm):</b>	15	30

- **Max. stapling depth (for paper insertion):** 47 mm

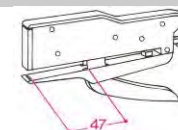

- <b>Colours:</b>	BLUE (JEANS)
• <b>Packaging:</b>	box containing a stapler and a box of "ZENITH" staples ref. 130/E
• <b>Box dimensions:</b>	15,4 x 8,7 x 1,6 cm
• <b>Weight:</b>	240 g (net) / 285 g (gross, including a box of "ZENITH" staples ref. 130/E)
• <b>N° of items per carton:</b>	60 (packets of 10 pieces)
• <b>Carton dimensions:</b>	32,5 x 27 x 21 cm (AxBxC)
• <b>Carton weight:</b>	17,5 Kg

**Loading system:** rear loading, with extractable pusher

**Patented anti-jamming device.**

The plier directions are on the back of the packaging.

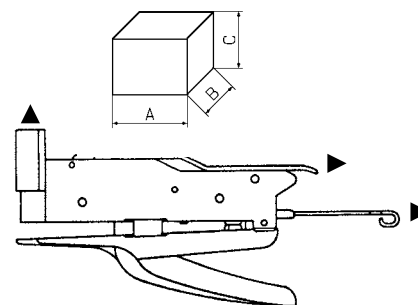

## Descriptive notes:

The JEANS version of the "ZENITH" stapler ref. 548/E has aesthetic characteristics and colour shades similar to the Denim fabric, the fabric of Jeans trousers.

Even the surfaces of the body and of the handle have a light, pleasant roughness, which reminds of that fabric. Thanks to the special application procedure of enamels of different colours, each piece, in terms of hue and shades, appears different from the others, thus becoming essentially unique!

It is a special limited edition, accompanied by a nice packaging which presents the product in an original way; moreover, a small cardboard inserted inside (that resembles a jeans label) best illustrates its special characteristics.

The technical and functional features are the same as the standard ZENITH 548/E.

**Quality:** to maintain the high quality standard guaranteed by all "ZENITH" products, each plier stapler is tested piece by piece. **Life-Guarantee for manufacturing defects.**

**In addition:** "ZENITH" 548/E has been improved over the years through many technical innovations unknown to the end user but useful to enhance its already envious perfection.

"ZENITH" 548/E JEANS can also staple with the "ZENITH" staples ref. 130/Z6 (length of legs 6 mm) up to 30 sheets!

# "ZENITH" 548/E CENTURY PLIER STAPLER



## Materials:

- made entirely in painted metal with nickel-plated finishing
- lead free enamel painting highly resisting wear and corrosion

## Technical / functional features:

• <b>Stapling:</b>		
• <b>Staple type:</b>	6/4	6/6
• <b>"ZENITH" staple ref.:</b>	130/E - 130/Z 130/LM - 130/LL	130/Z 6
• <b>Loading capacity (N° of staples):</b>	100	100
• <b>Stapling capacity (N° of sheets - 80 g/sqm):</b>	15	30

- **Max. stapling depth (for paper insertion):** 47 mm

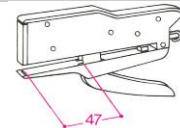

• <b>Colours:</b>	WHITE
• <b>Packaging:</b>	box containing a stapler and a box of "ZENITH" staples ref. 130/E
• <b>Box dimensions:</b>	15,4 x 8,7 x 1,6 cm
• <b>Weight:</b>	240 g (net) / 285 g (gross, including a box of "ZENITH" staples ref. 130/E)
• <b>N° of items per carton:</b>	60 (packets of 10 pieces)
• <b>Carton dimensions:</b>	32,5 x 27 x 21 cm (AxBxC)
• <b>Carton weight:</b>	17,5 Kg

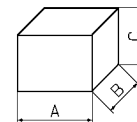

**Loading system:** rear loading, with extractable pusher

**Patented anti-jamming device.**

The plier directions are on the back of the packaging.

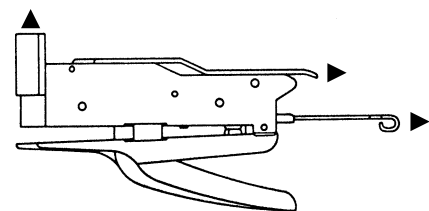

## Descriptive notes:

As a leader, "ZENITH" 548/E is used every day by millions of users who are satisfied with its quality, practicality, strength and endless capacity to function, even after years of continuous use.

**Quality:** to maintain the high quality standard guaranteed by all "ZENITH" products, each plier stapler is tested piece by piece. **Life-guarantee for manufacturing defects.**

**In addition:** "ZENITH" 548/E CENTURY is a special, limited edition, made to celebrate the 100th anniversary of "ZENITH" brand; in fact, it shows the brand "ZENITH 100 years" and it is supplied in a personalized box. The technical characteristics and performances are the same as the standard "ZENITH" 548/E staplers.

"ZENITH" 548/E CENTURY can also staple with the "ZENITH" staples ref. 130/Z6 (length of legs 6 mm) up to 30 sheets!

# "ZENITH" 548/E Pastel ESP 6

## DESK DISPLAY



## Dimensions and weights:

• Width :	26 cm
• Max. depth :	22,5 cm
• Height :	16 / 35 (*) cm
• Weight (when full) :	2,4 Kg.
• Content:	n.2 • ref. 548/E Pastel Gi n.2 • ref. 548/E Pastel Rs n.2 • ref. 548/E Pastel Az
• Desk displays per carton :	4
• Carton dimensions :	cm 66 x 31 x 40 (AxBxC)
• Carton weight :	11,5 Kg.

(\*) The height is measured with the open crowner.

## Descriptive notes:

Made in thick carton with a crowner wearing the new colours of the "ZENITH" stapler ref. 548/E Pastel, the desk display specially realised for this model gives the possibility to present in the best way six staplers assorted in the three available colours.

Of small weight and dimensions, it is fit to be shown in every point of sale and it is practical and functional for every shop window and showcase.

# "ZENITH" 548/E2

## PLIER STAPLER

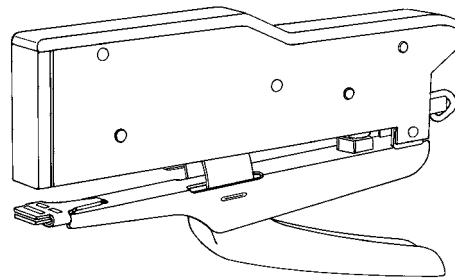

### Materials:

- Made entirely in painted metal with nickel-plated finishing
- lead free enamel painting highly resisting wear and corrosion



### Technical / functional features:

- **Stapling:**



- **Staple type:**

6/4

6/6

- **"ZENITH" staple ref.:**

130/E - 130/Z  
130/LM - 130/LL

130/Z 6

- **Loading capacity (N° of staples):**

100

100

- **Stapling capacity (N° of sheets - 80 g/sqm):**

15

30

- **Max. stapling depth (for paper insertion):**

47 mm

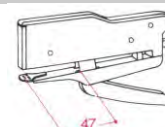

- **Colour:**

ALUMINIUM

- **Packaging:**

box containing a stapler and  
a box of "ZENITH" staples ref. 130/E

- **Box dimensions:**

15,4 x 8,7 x 1,6 cm

- **Weight:**

245 g (net) / 290 g (gross, including a box of  
"ZENITH" staples ref. 130/E)

- **N° of items per carton:**

60 (packets of 10 pieces)

- **Carton dimensions:** 32,5 x 27 x 21 cm (AxBxC)

- **Carton weight:** 17,5 Kg

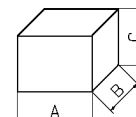

**Loading system:** rear loading, with extractable pusher

**Patented anti-jamming device.**

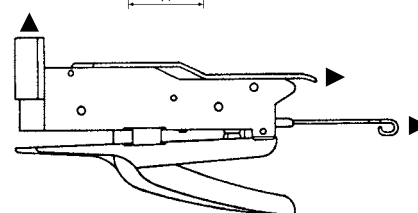

The plier directions are on the back of the packaging.

### Descriptive notes:

"ZENITH" 548/E2 offers the same performance of "ZENITH" 548 making it a strong and reliable stapler. The only difference is the finishing in nickel-plated metal.

**Quality:** to maintain the high quality standard guaranteed by all "ZENITH" products, each plier stapler is tested piece by piece. **Life-Guarantee for manufacturing defects.**

**In addition:** "ZENITH" 548/E2 offers the possibility to choose between permanent or temporary stapling; in the latter it is easy to remove the staple even without the staple-remover.

"ZENITH" 548/E2 can also staple with the "ZENITH" staples ref. 130/Z6 (length of legs 6 mm) up to 30 sheets!



# "ZENITH" 590

## PLIER STAPLER

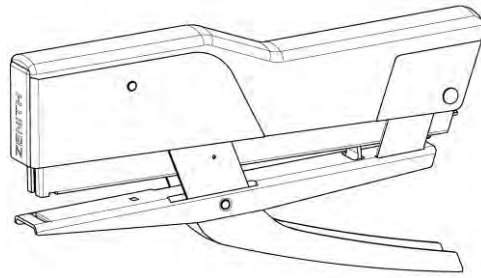

### Materials:

- metal body and mechanical parts
- ABS anti-shock plastic cap
- lead free enamel painting highly resisting wear and corrosion

### Technical / functional features:

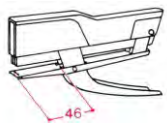
• <b>Stapling:</b>		
• <b>Staple type:</b>	6/4	6/6
• <b>"ZENITH" staple ref.:</b>	130/E - 130/Z 130/LM - 130/LL	130/Z 6
• <b>Loading capacity (N° of staples):</b>	200	200
• <b>Stapling capacity (N° of sheets - 80 g/sqm):</b>	15	30
• <b>Max. stapling depth (for paper insertion):</b>	46 mm	
• <b>Colours:</b>	TRANSPARENT/ALUMINIUM - BLACK RED/BEIGE - GREY/BEIGE - BEIGE	
• <b>Packaging:</b>	box containing a stapler and a box of "ZENITH" staples ref. 130/E	
• <b>Box dimensions:</b>	16 x 9 x 2,4 cm	
• <b>Weight:</b>	187 g (net) / 230 g (gross, including a box of "ZENITH" staples ref. 130/E)	
• <b>N° of items per carton:</b>	60 (packets of 10 pieces)	
• <b>Carton dimensions:</b>	35 x 37 x 22 cm (AxBxC)	
• <b>Carton weight:</b>	14,5 Kg	

**Loading system:** top loading; pull-down the handle, pull-up the cap and insert staples

### Patented anti-jamming device.

The plier directions are on the back of the packaging.

### Descriptive notes:

"ZENITH" 590 has been on the market since 1990 and it is appreciated by a growing number of end-users; in fact it offers all the best features of the "ZENITH" line of plier staplers, in particular, efficiency of working, endurance and high level of finishing,...perfect for all kinds of uses - at home, in school and in the office.

**Quality:** to maintain the high quality standard guaranteed by all "ZENITH" products, each plier stapler is tested piece by piece. Life-Guarantee for manufacturing defects.

**In addition:** "ZENITH" 590 is light, handy and most importantly effortless to use; the loading system is easy and quick with a loading capacity up to 200 staples. **The cap, in ABS, has been re-designed with more rounded lines giving to the stapler, besides a more attractive aesthetics, also a better ergonomics.**

"ZENITH" 590 can also staple with the "ZENITH" staples ref. 130/Z6 (length of legs 6 mm) up to 30 sheets!

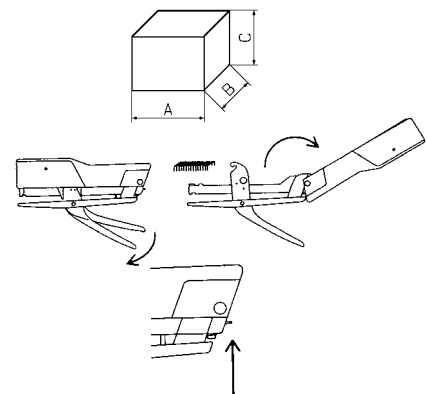



# "ZENITH" 590 MET

## PLIER STAPLER

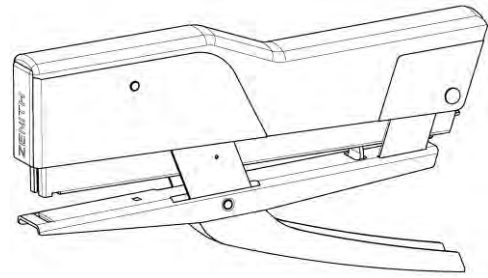

### Materials:

- metal body and mechanical parts
- ABS anti-shock transparent coloured cap
- lead free enamel painting highly resisting wear and corrosion

### Technical / functional features:

• <b>Stapling:</b>		
• <b>Staple type:</b>	6/4	6/6
• <b>"ZENITH" staple ref.:</b>	130/E - 130/Z 130 LM – 130 LL	130/Z 6
• <b>Loading capacity (N° of staples):</b>	200	200
• <b>Stapling capacity (N° of sheets - 80 g/sqm):</b>	15	30

- **Max. stapling depth (for paper insertion):** 46 mm

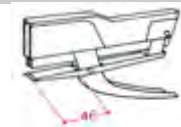

- **Colours:** Metallic red bordeaux, Metallic green, Metallic blue

- **Packaging:** box containing a stapler and a box of "ZENITH" staples ref. 130/E

- **Box dimensions:** 16 x 9 x 2,4 cm

- **Weight:** 187 g (net) / 230 g (gross, including a box of "ZENITH" staples ref. 130/E)

- **N° of items per carton:** 60 (packets of 10 pieces)

- **Carton dimensions:** 35 x 37 x 22 cm (AxBxC)

- **Carton weight:** 14,5 Kg

**Loading system:** top loading; pull-down the handle, pull-up the cap and insert staples

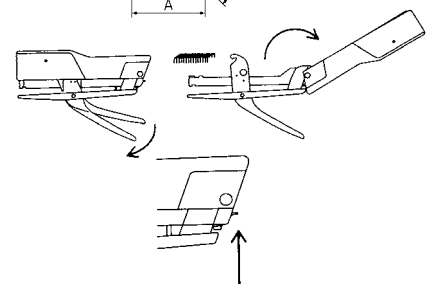

### Patented anti-jamming device.

The plier directions are on the back of the packaging.

### Descriptive notes:

"ZENITH" 590 MET offers the same performance of "ZENITH" 590, resulting perfect for all kinds of uses - at home, in school and in the office.

**Quality:** to maintain the high quality standard guaranteed by all "ZENITH" products, each plier stapler is tested piece by piece. **Life-Guarantee for manufacturing defects.**

### In addition:

"ZENITH" stapler 590 MET is available in three captivating combinations of hi-tech metal colours, with transparent ABS coloured cap and metal parts of the same dye. The brilliant enamel painting is lead free (fully respecting the laws against pollution).

"ZENITH" 590 MET can also staple with the "ZENITH" staples ref. 130/Z6 (length of legs 6 mm) up to 30 sheets!

# "ZENITH" 590 FUN

## PLIER STAPLER

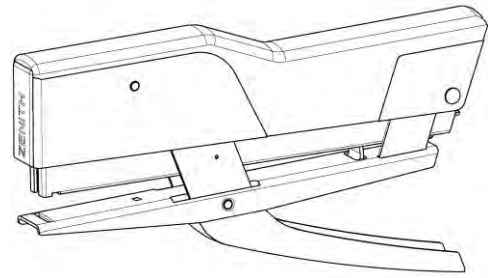

### Materials:

- metal body and mechanical parts
- ABS anti-shock transparent coloured cap
- lead free enamel painting highly resisting wear and corrosion

### Technical / functional features:

• <b>Stapling:</b>		
• <b>Staple type:</b>	6/4	6/6
• <b>"ZENITH" staple ref.:</b>	130/E - 130/Z 130/LM - 130/LL	130/Z 6
• <b>Loading capacity (N° of staples):</b>	200	200
• <b>Stapling capacity (N° of sheets - 80 g/sqm):</b>	15	30

- **Max. stapling depth (for paper insertion):** 46 mm

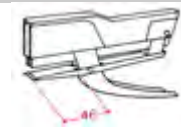

• <b>Colours:</b>	Transp.red/white - Transp.yellow/white - Transp.green/white - Transp.blue/white - Transp.violet/white
• <b>Packaging:</b>	box containing a stapler and a box of "ZENITH" staples ref. 130/E
• <b>Box dimensions:</b>	16 x 9 x 2,4 cm
• <b>Weight:</b>	187 g (net) / 230 g (gross, including a box of "ZENITH" staples ref. 130/E)
• <b>N° of items per carton:</b>	60 (packets of 10 pieces)
• <b>Carton dimensions:</b>	35 x 37 x 22 cm (AxBxC)
• <b>Carton weight:</b>	14,5 Kg

**Loading system:** top loading; pull-down the handle, pull-up the cap and insert staples

### Patented anti-jamming device.

The plier directions are on the back of the packaging.

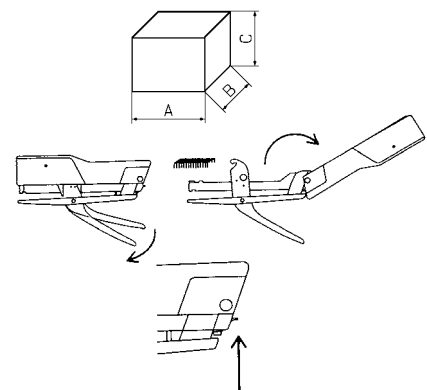

### Descriptive notes:

"ZENITH" 590 FUN offers the same performance of "ZENITH" 590, resulting perfect for all kinds of uses - at home, in school and in the office.

**Quality:** to maintain the high quality standard guaranteed by all "ZENITH" products, each plier stapler is tested piece by piece. **Life-Guarantee for manufacturing defects.**

**In addition:** "ZENITH" 590 FUN offers the choice among five alluring colour combinations. Furthermore, through the transparent coloured cap it is possible to see the perfect working of its inner mechanism.

"ZENITH" 590 FUN can also staple with the "ZENITH" staples ref. 130/Z6 (length of legs 6 mm) up to 30 sheets!

# "ZENITH" 590 MIX

## PLIER STAPLER

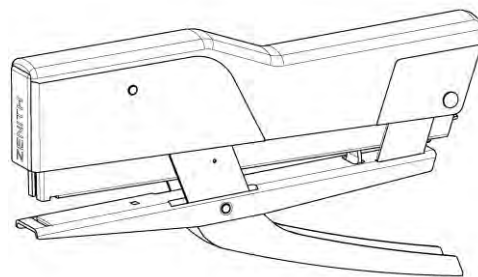

### Materials:

- metal body and mechanical parts
- ABS anti-shock transparent coloured cap
- lead free enamel painting highly resisting wear and corrosion

### Technical / functional features:

• <b>Stapling:</b>		
• <b>Staple type:</b>	6/4	6/6
• <b>"ZENITH" staple ref.:</b>	130/E - 130/Z 130 LM - 130 LL	130/Z 6
• <b>Loading capacity (N° of staples):</b>	200	200
• <b>Stapling capacity (N° of sheets - 80 g/sqm):</b>	15	30

- **Max. stapling depth (for paper insertion):** 46 mm



- **Colours:** Red cap and yellow, green and blue metal parts

- **Packaging:** box containing a stapler and a box of "ZENITH" staples ref. 130/E

- **Box dimensions:** 16 x 9 x 2,4 cm

- **Weight:** 187 g (net) / 230 g (gross, including a box of "ZENITH" staples ref. 130/E)

- **N° of items per carton:** 60 (packets of 10 pieces)

- **Carton dimensions:** 35 x 37 x 22 cm (AxBxC)

- **Carton weight:** 14,5 Kg

**Loading system:** top loading; pull-down the handle, pull-up the cap and insert staples

### Patented anti-jamming device.

The plier directions are on the back of the packaging.

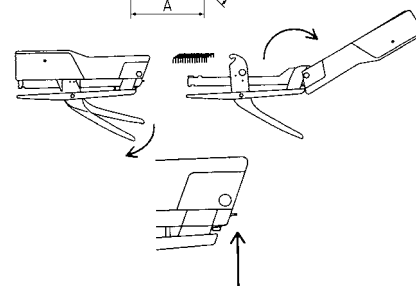

### Descriptive notes:

"ZENITH" 590 MIX offers the same performance of "ZENITH" 590, resulting perfect for all kinds of uses - at home, in school and in the office.

**Quality:** to maintain the high quality standard guaranteed by all "ZENITH" products, each plier stapler is tested piece by piece. **Life-Guarantee for manufacturing defects.**

### In addition:

"ZENITH" 590 MIX brings still more colours and vivacity in the office, thanks to its combination of four colours (red cap and yellow, green and blue metal parts) and to its colourful box too!

"ZENITH" 590 family offers now a choice of no less than 14 colours among ref. 590, 590 FUN, 590 MET and 590 MIX.

"ZENITH" 590 MIX can also staple with the "ZENITH" staples ref. 130/Z6 (length of legs 6 mm) up to 30 sheets!

# "ZENITH" 590 TECH

## PLIER STAPLER

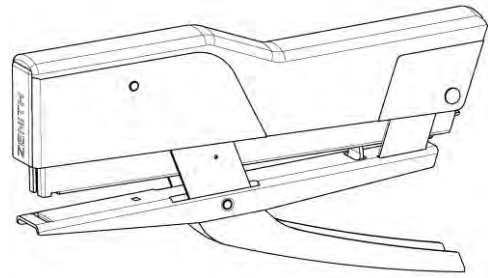

### Materials:

- metal body and mechanical parts
- ABS anti-shock plastic cap
- lead free enamel painting highly resisting wear and corrosion

### Technical / functional features:

• <b>Stapling:</b>		
• <b>Staple type:</b>	6/4	6/6
• <b>"ZENITH" staple ref.:</b>	130/E - 130/Z 130/LM - 130/LL	130/Z 6
• <b>Loading capacity (N° of staples):</b>	200	200
• <b>Stapling capacity (N° of sheets - 80 g/sqm):</b>	15	30

- **Max. stapling depth (for paper insertion):** 46 mm

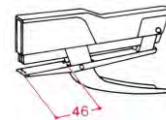

- **Colours:** Cap: black carbon – body: black  
Cap: aluminium wave – body: aluminium  
Cap: white wave – body: white

- **Packaging:** box containing a stapler and a box of "ZENITH" staples ref. 130/E
- **Box dimensions:** 16 x 9 x 2,4 cm
- **Weight:** 187 g (net) / 230 g (gross, including a box of "ZENITH" staples ref. 130/E)
- **N° of items per carton:** 60 (packets of 10 pieces)

- **Carton dimensions:** 35 x 37 x 22 cm (AxBxC)
- **Carton weight:** 14,5 Kg

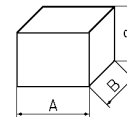

**Loading system:** top loading; pull-down the handle, pull-up the cap and insert staples

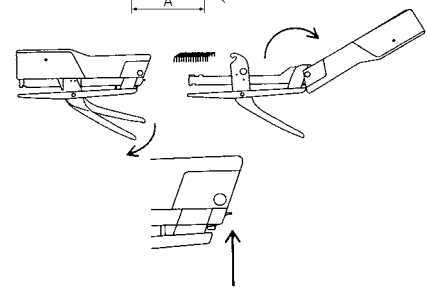

### Patented anti-jamming device.

The plier directions are on the back of the packaging.

### Descriptive notes:

The "ZENITH" stapler 590 TECH maintains all the best characteristics of the "ZENITH" line of 590 staplers, in terms of functionality, durability and level of finishes, which make it perfect for any situation of use, at home, at school and in the office.

**Quality:** to maintain the high quality standard guaranteed by all "ZENITH" products, each plier stapler is tested piece by piece. **Life-Guarantee for manufacturing defects.**

**In addition:** The three special colour combinations for the cap/body paint give the "ZENITH" 590 TECH a more modern and "technical" look, according to the current trends, as also highlighted by the black/grey tones of the elegant packaging, made specially for this version.

"ZENITH" 590 TECH can also staple with the "ZENITH" staples ref. 130/Z6 (length of legs 6 mm) up to 30 sheets!

# "ZENITH" 590 CRAFT

## PLIER STAPLER

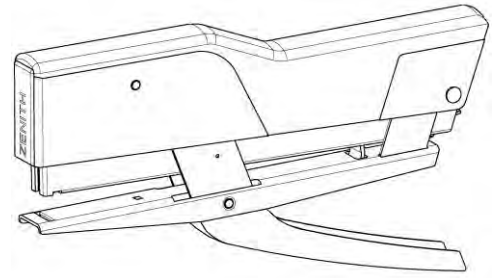

### Materials:

- metal body and mechanical parts
- ABS anti-shock plastic cap
- lead free enamel painting highly resisting wear and corrosion



### Technical / functional features:

• <b>Stapling:</b>		
• <b>Staple type:</b>	6/4	6/6
• <b>"ZENITH" staple ref.:</b>	130/E - 130/Z 130/LM - 130/LL	130/Z 6
• <b>Loading capacity (N° of staples):</b>	200	200
• <b>Stapling capacity (N° of sheets - 80 g/sqm):</b>	15	30

- **Max. stapling depth (for paper insertion):** 46 mm

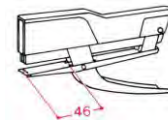

- **Colours:** Cap: wood colour – body: iridescent gold

- **Packaging:** box containing a stapler and a box of "ZENITH" staples ref. 130/E
- **Box dimensions:** 16 x 9 x 2,4 cm
- **Weight:** 187 g (net) / 230 g (gross, including a box of "ZENITH" staples ref. 130/E)
- **N° of items per carton:** 60 (packets of 10 pieces)
- **Carton dimensions:** 35 x 37 x 22 cm (AxBxC)
- **Carton weight:** 14,5 Kg

**Loading system:** top loading; pull-down the handle, pull-up the cap and insert staples

### Patented anti-jamming device.

The plier directions are on the back of the packaging.

### Descriptive notes:

The "ZENITH" stapler 590 CRAFT maintains all the best characteristics of the "ZENITH" line of 590 staplers, in terms of functionality, durability and level of finishes, which make it perfect for any situation of use, at home, at school and in the office.

**Quality:** to maintain the high quality standard guaranteed by all "ZENITH" products, each plier stapler is tested piece by piece. **Life-Guarantee for manufacturing defects.**

**In addition:** the original combination of the wood-colored cap with the bright body paint in the iridescent gold color makes the "ZENITH" 590 CRAFT stapler not only a handy work tool, but also a nice gift idea, enhanced by the elegant packaging.

"ZENITH" 590 CRAFT can also staple with the "ZENITH" staples ref. 130/Z6 (length of legs 6 mm) up to 30 sheets!

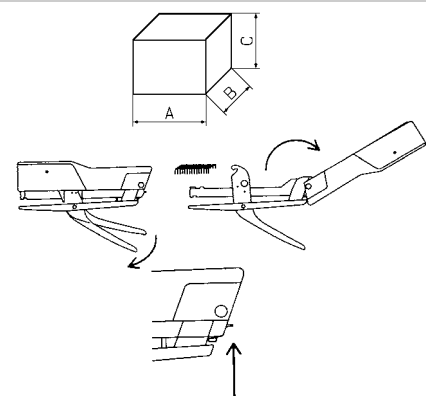

# "ZENITH" 590 TECH ESP 6

## DESK DISPLAY



### Dimensions and weights:



• Width :	26 cm
• Max. depth :	22,5 cm
• Height :	16 / 35 (*) cm
• Weight (when full) :	1,6 Kg.
• Content:	n.2 • ref. 590 TECH BC n.2 • ref. 590 TECH AW n.2 • ref. 590 TECH WW
• Desk displays per carton :	4
• Carton dimensions :	cm 66 x 31 x 40 (AxBxC)
• Carton weight :	11 Kg.

(\*) The height is measured with the open crowner.

### Descriptive notes:

Made in thick carton with a crowner wearing the new colours of the "ZENITH" stapler ref. 590 TECH, the desk display specially realised for this model gives the possibility to present in the best way six staplers assorted in the three available colours.

Of small weight and dimensions, it is fit to be shown in every point of sale and it is practical and functional for every shop window and showcase.



# "ZENITH" 591

## PLIER STAPLER

### Materials:

- metal body and mechanical parts
- ABS anti-shock plastic cap
- lead free enamel painting highly resisting wear and corrosion

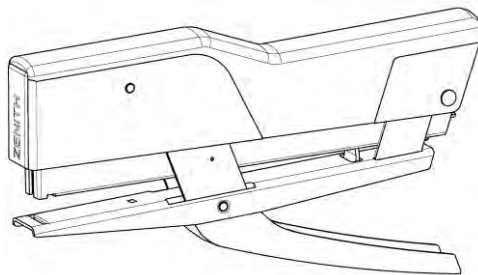

### Technical / functional features:

- **Stapling:**



- **Staple type:**

N° 10

- **"ZENITH" staple ref.:**

110

- **Loading capacity (N° of staples):**

200

- **Stapling capacity (N° of sheets - 80 g/sqm):**

15

- **Max. stapling depth (for paper insertion):**

46 mm

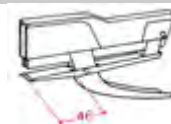

- **Colours:**

Black - Red/black - Yellow/beige - Beige - Transparent/beige

- **Packaging:**

box containing a stapler and a box of "ZENITH" staples ref. 110

- **Box dimensions:**

16 x 9 x 2,5 cm

- **Weight:**

192 g (net) / 240 g (gross, including a box of "ZENITH" staples ref. 110)

- **N° of items per carton:**

80 (packets of 5 pieces)

- **Carton dimensions:** 54 x 35 x 21,5 cm (AxBxC)

- **Carton weight:** 20,5 Kg

**Loading system:** top loading; pull-down the handle, pull-up the cap and insert staples

### Patented anti-jamming device.

The plier directions are on the back of the packaging.

### Descriptive notes:

"ZENITH" 591 offers all the best features of the "ZENITH" line of plier staplers; it works with N° 10 staples (world-wide known standard) earning more and more success in many countries, also outside Europe..

**Quality:** to maintain the high quality standard guaranteed by all "ZENITH" products, each plier stapler is tested piece by piece. **Life-Guarantee for manufacturing defects.**

**In addition:** "ZENITH" 591 presents exceptional characteristics such as its easy loading system (top loading, without extractable pusher), magazine capacity up to 200 staples, light weight, easy handling, high degree of finishing and incredible effortless usage, impossible to describe but...a must try !

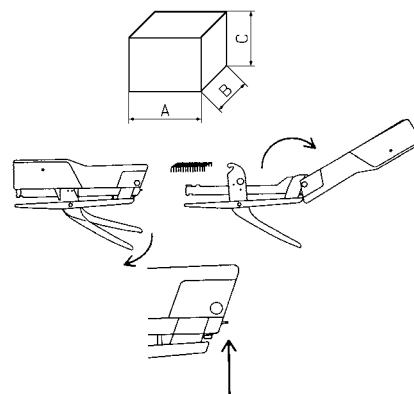

# "ZENITH" 591 FUN

## PLIER STAPLER

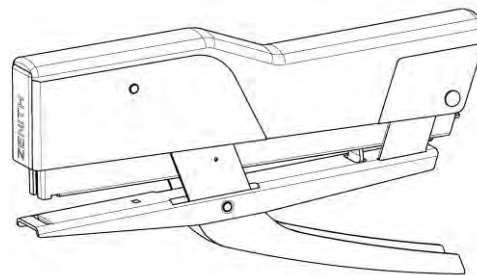

### Materials:

- metal body and mechanical parts
- ABS anti-shock transparent coloured cap
- lead free enamel painting highly resisting wear and corrosion

### Technical / functional features:

• Stapling:	
• Staple type:	N° 10
• "ZENITH" staple ref.:	110
• Loading capacity (N° of staples):	200
• Stapling capacity (N° of sheets - 80 g/sqm):	15

- Max. stapling depth (for paper insertion): 46 mm



- Colours: Transp.red/white - Transp.yellow/white - Transp.green/white - Transp.blue/white - Transp.violet/white

- Packaging: box containing a stapler and a box of "ZENITH" staples ref. 110

- Box dimensions: cm 16 x 9 x 2,5

- Weight: 192 g (net) / 240 g (gross, including a box of "ZENITH" staples ref. 110)

- N° of items per carton: 80 (packets of 5 pieces)

- Carton dimensions: cm 54 x 35 x 21,5 (AxBxC)

- Carton weight: Kg. 20,5

**Loading system:** top loading; pull-down the handle, pull-up the cap and insert staples

**Patented anti-jamming device.**

The plier directions are on the back of the packaging.

### Descriptive notes:

"ZENITH" 591 FUN offers the same performance of "ZENITH" 591, working with N° 10 staples.

**Quality:** to maintain the high quality standard guaranteed by all "ZENITH" products, each plier stapler is tested piece by piece. **Life-Guarantee for manufacturing defects.**

**In addition:** "ZENITH" 591 FUN too (like 591 model) features the top loading system, a magazine capacity up to 200 staples and an incredible effortless usage. The five alluring colour combinations available can undoubtedly satisfy every user's tastes; furthermore, through the transparent coloured cap it is easy to see the perfect working of its inner mechanism.

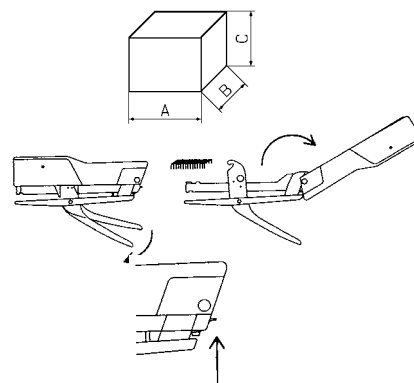



# "ZENITH" 551

## PLIER STAPLER

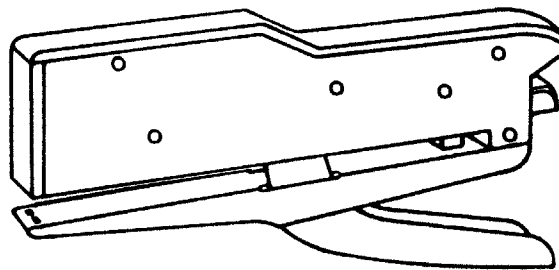

### Materials:

- made entirely in painted metal with nickel-plated finishing
- lead free enamel painting highly resisting wear and corrosion

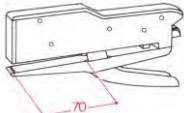

### Technical / functional features:

• Stapling:			
• Staple type:	24/6		24/8
• "ZENITH" staple ref.:	515 - 115		515/8 - 115/8
• Loading capacity (N° of staples):		150	
• Stapling capacity (N° of sheets - 80 g/sqm):	20		35
• Max. stapling depth (for paper insertion):	70 mm		
• Colours:	GREY/LIGHT GREY - ALUMINIUM		
• Packaging:	box containing a stapler and a box of "ZENITH" staples ref. 515		
• Box dimensions:	18,7 x 10,4 x 2,2 cm		
• Weight:	435 g (net) / 530 g (gross, including a box of "ZENITH" staples ref. 515)		
• N° of items per carton:	30 (packets of 5 pieces)		
• Carton dimensions:	33,5 x 25 x 21,5 cm (AxBxC)		
• Carton weight:	16 Kg		

**Loading system:** rear loading, with extractable pusher

**Patented anti-jamming device.**

The plier directions are on the back of the packaging.

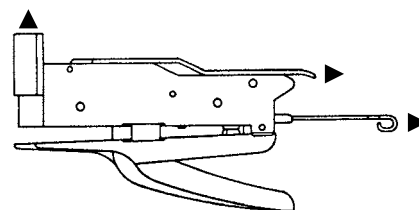

### Descriptive notes:

"ZENITH" 551 is a very strong plier stapler suitable not only for paper but also for thincards, cardboard and so on, especially when the user prefers the easy handling of a plier stapler rather than a desk stapler.

**Quality:** to maintain the high quality standard guaranteed by all "ZENITH" products, each plier stapler is tested piece by piece. **Life-Guarantee for manufacturing defects.**

**In addition:** "ZENITH" 551 combines versatility with exceptional strength, considerable stapling capacity (up to 35 sheets) and good loading capacity up to 150 staples.

# "ZENITH" 595

## PLIER STAPLER

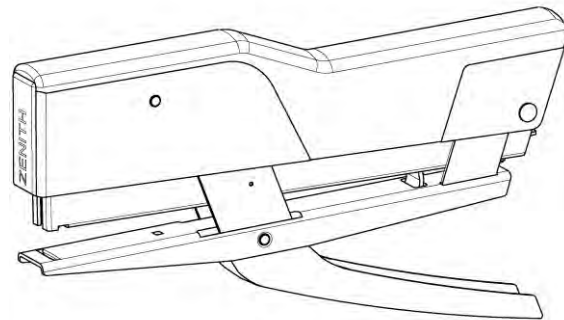

### Materials:

- metal body and mechanical parts
- ABS anti-shock plastic cap
- lead free enamel painting highly resisting wear and corrosion

### Technical / functional features:

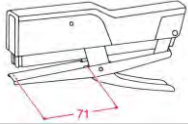
• <b>Stapling:</b>		
• <b>Staple type:</b>	24/6 - 24/8	26/6 - 26/8
• <b>"ZENITH" staple ref.:</b>	515 - 115	512 - 112
• <b>Loading capacity (N° of staples):</b>	200	250
• <b>Stapling capacity (N° of sheets - 80 g/sqm):</b>	20 (24/6 - 26/6 stap.)	35 (24/8 - 26/8 stap.)
• <b>Max. stapling depth (for paper insertion):</b>	71 mm	
• <b>Colours:</b>	BLACK - RED/BEIGE	
• <b>Packaging:</b>	box containing a stapler and a box of "ZENITH" staples ref. 515	
• <b>Box dimensions:</b>	20 x 10,5 x 2,8 cm	
• <b>Weight:</b>	313 g (net) / 400 g (gross, including a box of "ZENITH" staples ref. 515)	
• <b>N° of items per carton:</b>	30 (packets of 5 pieces)	
• <b>Carton dimensions:</b>	34 x 30,5 x 23 cm (AxBxC)	
• <b>Carton weight:</b>	13 Kg	

**Loading system:** top loading; pull-down the handle, pull-up the cap and insert staples

### Patented anti-jamming device.

The plier directions are on the back of the packaging.

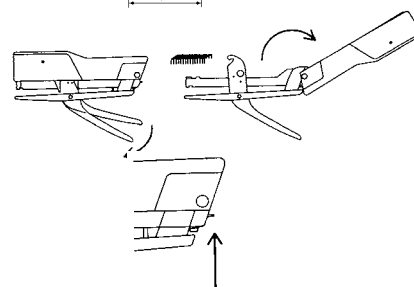

### Descriptive notes:

"ZENITH" 595 is the result of over 80 years of Balma, Capoduri's experience in manufacturing staplers. "ZENITH" 595 combines qualities of great strength, unique lightness and incredible effortless usage for handy and easy use by everyone, particularly for works of a certain care such as stapling cardboard, thincards etc.

**Quality:** to maintain the high quality standard guaranteed by all "ZENITH" products, each plier stapler is tested piece by piece. ***Life-Guarantee for manufacturing defects.***

**In addition:** it is easy to use because of the top loading system, where you simply pull-up the cap; unique in its kind, "ZENITH" 595 can staple indifferently with four staple types: 24/6 - 24/8 (loading capacity of 200 staples), 26/6 - 26/8 (loading capacity of 250 staples). It is even more effortless when using 26/6 and 26/8 staples.

# "ZENITH" 580

## STAPLE-REMOVER

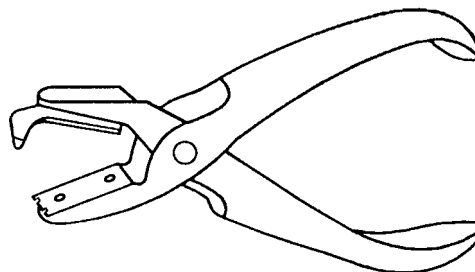

### Materials:

- made in nickelated iron with small beak and plate with incisions in hardened and nickelated steel

**Weight:** 78 g (net) / 95 g (gross)

**Box dimensions:** 14,2 x 7,5 x 1,5 cm

**N° of items per carton:** 240 (packets of 10 pieces)

**Carton dimensions:** 48 x 30 x 35,5 cm (AxBxC)

**Carton weight:** 23 Kg

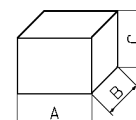

**Descriptive notes:** in spite of many imitations in Italy and abroad, "ZENITH" 580 staple-remover can be considered "unique" for its technical and aesthetical perfection, accuracy, high degree of finishing and its well researched handle design.

**In addition:** the steel parts which extract the staples, ( e.g. wedge-shaped small beak and incision plate), make the "ZENITH" 580 work perfectly practically for ever and maintain its exceptional performance over the years. "ZENITH" 580 easily removes both "ZENITH" ref. 515-112-130 staples and other staples of different standard.

**Quality:** to maintain the high quality standard guaranteed by all "ZENITH" products, each staple-remover is tested piece by piece. **Life-Guarantee for manufacturing defects.**

\* \* \* \*

# "ZENITH" 585

## STAPLE-REMOVER AND LETTER OPENER

### Materials:

- small beak and plate with incisions in hardened and nickelated steel  
- nickelated iron blade



**Weight:** 44 g (net) / 55 g (gross)

**Box dimensions:** 26 x 3 x 1,8 cm

**N° of items per carton:** 10

**Descriptive notes:** for those who like nice and practical things, "ZENITH" 585 offers a unique product combining a smart letter opener and an efficient staple-remover, perfectly suitable to easily remove "ZENITH" ref. 515-112-130 staples and other staples of different standard.

**Quality:** to maintain the high quality standard guaranteed by all "ZENITH" products, each staple-remover is tested piece by piece. **Life-Guarantee for manufacturing defects.**

# "ZENITH" 580 GOLD

## STAPLE-REMOVER

### Materials:

- made in nickelated iron with small beak and plate with incisions in hardened and nickelated steel
- golden finishing (24 carats)



**Weight:** 78 g (net) / 116 g (gross)

**Box dimensions:** 17 x 11 x 1,7 cm

**Descriptive notes:** unique article for technical and aesthetic perfection, manufacturing procedures, ergonomic handle, high degree of finishing embellished in the "Gold" version with careful gold plating and an elegant box.

**In addition:** the steel parts which extract the staples (i.e. the wedge-shaped small beak and the incision plate), make the "ZENITH" 580 work perfectly practically for ever and maintain its exceptional performance over the years. "ZENITH" 580 easily removes "ZENITH" staples ref. 515-112-130 and other staples of different standards.

**Quality:** to maintain the high quality standard guaranteed by all "ZENITH" products, each staple-remover is tested piece by piece. **Life-Guarantee for manufacturing defects.**

\* \* \* \*

# "ZENITH" 585 GOLD

## STAPLE-REMOVER AND LETTER OPENER

### Materials:

- small beak and plate with incisions in hardened and nickelated steel with golden finishing
- nickelated iron blade with golden finishing
- golden finishing (23 carats)



**Weight:** 44 g (net) / 55 g (gross)

**Box dimensions:** 26 x 3 x 1,8 cm

**N° of items per carton:** 10

**Descriptive notes:** a golden finishing embellishes and makes even more exclusive the elegant and sharp lines of ZENITH 585, thought to shine and stand out on the desks of those who love nice and useful objects.

In addition to being a handy letter-opener, it easily removes different wire staples: ZENITH MIL, ZENITH 130 series and other staples of different sizes.

**Quality:** to maintain the high quality standard guaranteed by all "ZENITH" products, each staple-remover is tested piece by piece. **Life-Guarantee for manufacturing defects.**

# "ZENITH" 586

## STAPLE-REMOVER

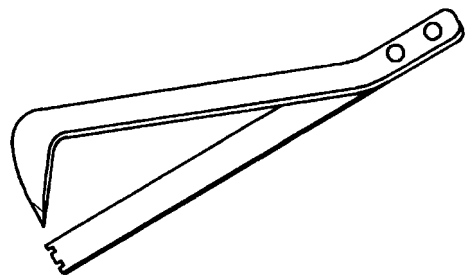

### Materials:

- made in hardened and nickelated steel



<b>Weight:</b>	26 g (net) / 31 g (gross)
<b>Box dimensions:</b>	9,7 x 3 x 1,9 cm
<b>N° of items per carton:</b>	100 (packets of 10 pieces)
<b>Carton dimensions:</b>	33 x 18 x 17 cm (AxBxC)
<b>Carton weight:</b>	3,5 Kg

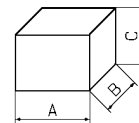

**Descriptive notes:** Technical and aesthetical perfection of the whole "ZENITH" line continues in the "ZENITH" 586 staple-remover. In this new really "pocket-size" article too, you can find a careful choice of the best materials, an excellent finishing degree and a remarkable working precision, typical of all "ZENITH" products. It is available either in box or in blister packaging.

**In addition:** being made in hardened steel, it grants very high performances. "ZENITH" 586 easily removes both "ZENITH" ref. 515-112-130 staples and other staples of different standard.

**Quality:** to maintain the high quality standard guaranteed by all "ZENITH" products, each staple-remover is tested piece by piece. ***Life-Guarantee for manufacturing defects.***

## "ZENITH" STAPLES

Staple type	"ZENITH" staple ref.	Length of legs	Wire quality	Staples per little box	Net/gross weight (g)	Little boxes per case	Little boxes per packet	Little boxes per carton	Carton dimensions (cm)	Carton Weight (kg)	Supply for "ZENITH" staplers ref.
24/6	515	6	plain wire	1000	51 / 56	-	10	300	34 x 23,5 x 22	17	
24/8	515 bis	6	plain wire	5000	255 / 270	-	5	50	30 x 21,5 x 22	14	
24/10	515/8 bis	8	plain wire	1000	57 / 62	-	10	300	33 x 26 x 26	20	501(**), 501/E(**), 500(*), 502(*), 506(**), 578(*), 520, 520/E, 520 Gold, 522, 522/E, 551(*), 595 (*), 561(**), ELE 1 (*)
24/6	115/Z	6	zincplated wire	1000	51 / 56	-	10	300	38 x 32,5 x 24	24	
24/8	115/Z 8	8	zincplated wire	1000	58 / 64	-	10	300	34 x 23,5 x 22	17,5	
	115/LM	6	Monel alloy	1000	57 / 64	-	10	300	33 x 26 x 26	20,5	
	115/LL	6	Aluminium alloy	1000	17 / 22	-	10	300	34 x 23,5 x 22	20	
	115/8 LL	8	Aluminium alloy	1000	20 / 25	-	10	300	34 x 23,5 x 22	7,5	
	512	6	plain wire	5000	170 / 180	-	5	100	33 x 26 x 26	8	
	512/8	8	plain wire	5000	193 / 210	-	5	100	33 x 26 x 26	20	
26/6	512/LM	6	Monel alloy	5000	196 / 206	-	5	100	45 x 29 x 21	22	
26/8	512/8 LM	8	Monel alloy	5000	213 / 230	-	5	100	33 x 26 x 26	20	501(**), 501/E(**), 500, 502, 506, 578, 525, 526, ELE 1(**), 595
	112/Z	6	zincplated wire	1500	51 / 56	-	10	300	38 x 32 x 30,5	24	
	112/LM	6	Monel alloy	1500	56 / 60	-	10	300	35 x 24 x 24,5	17,5	
	130/Z	4	zincplated wire	1000	19 / 23	10	50	1000	35 x 24 x 24,5	20	
	130/Z bis	4	zincplated wire	5000	95 / 107	-	10	100	33 x 26 x 26	23	
	130/Z 6	6	zincplated wire	1000	24 / 28	10	50	500	33 x 18 x 17	11	
6/4	130/Z 6 bis	6	zincplated wire	5000	120 / 132	-	10	100	25 x 33 x 18,5	14,5	530, 548, 548 Gold, 548/E, 548/E TR, 548/E Pastel, 548/E Replay, 548/E SIXTY, 548/E AB, 548/E Jeans, 548/E2, 590, 590 FUN, 590 MET, 590 MIX, 590 TECH, 590 CRAFT
6/6	130/E	4	plain wire	1000	19 / 23	10	50	1000	33 x 18 x 20	14	
	130/E bis	4	plain wire	5000	95 / 107	-	10	100	33 x 26 x 26	23	
	130/LM	4	Monel alloy	1000	22 / 26	10	50	500	33 x 18 x 17	11	
	130/LM bis	4	Monel alloy	5000	110 / 125	-	10	100	27,5 x 26 x 17	13	
	130/LL	4	Aluminium alloy	1000	7 / 9,6	10	50	1000	33 x 18 x 17	13	
N° 10	110	5	zincplated wire	1000	21 / 24	10	50	600	33 x 26 x 26	10,5	
									34,5x28,5x19,5	15,5	591, 591 FUN

(\*) The stapler does not work with staple ref.515/10 - (\*\*\*) The stapler does not work with staple ref.515/8, 515/10, 115/Z8 and 115/8 LL - (\*\*) The stapler does not work with staple ref. 512/8 e 512/8 LM

**Notes:** for effortless stapling and good working of your staplers, "ZENITH" staples are remarkable for the high quality of the wire and for the particular grinding of the legs end, ensuring a better penetration. The high quality standard is the result of accurate production techniques and strict controls during the manufacturing and packing phases. This range offers many staple sizes and different types of wire suitable for any stapling need, for example, **zincplated wire** which gives better resistance to oxidation; **light aluminium alloy**, non-magnetic and anti-rust, ideal for little dossiers, used also to staple sheets of plywood without damaging the tools and **Monel alloy** (nickel and copper with traces of other metals) which is widely used for photographic development because of its resistance to acid solutions.

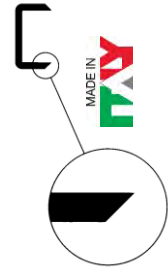

# "ZENITH" 815

## CORNER CLIPS



### Materials:

- made in stainless steel



## Technical / functional features

<b>Corner clips per box:</b>	50
<b>Box weight:</b>	35 g (gross weight)
<b>Box dimensions:</b>	cm 6,7 x 5,4 x 3
<b>No. of boxes per carton:</b>	96 (packets of 8 boxes)
<b>Carton dimensions:</b>	cm 30 x 20 x 17,5 (AxBxC)
<b>Carton weight:</b>	3,7 Kg.

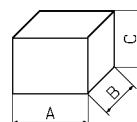

## Descriptive notes:

Innovative corner clips of triangular shape, called "Fermangoli" (registered trademark), whose novelty is in the material used (stainless steel) and also the fact that in addition to keeping the sheets together, thanks to their inclined side of 60° they allow to turn the pages easily, keeping them well firm in their place.

The box in its original design contains 50 pcs. and may be used as a dispenser too.

The blister version is also already available (ref. 815 blister - one box per blister).



# "ZENITH" 815

## GOLD

### CORNER CLIPS



#### Materials:

- made in golden steel (23 carats)



#### Technical / functional features

<b>Corner clips per box:</b>	50
<b>Box weight:</b>	35 g (gross weight)
<b>Box dimensions:</b>	cm 6,7 x 5,4 x 3
<b>No. of boxes per carton:</b>	96 (packets of 8 boxes)
<b>Carton dimensions:</b>	cm 30 x 20 x 17,5 (AxBxC)
<b>Carton weight:</b>	3,7 Kg.

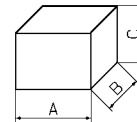

#### Descriptive notes:

A simple and at the same time innovative shape, to keep the sheets together but also turn them easily. These are the ZENITH GOLD corner clips, now also available in a simply special version.





# "ZENITH" 787

## PERFORATOR

### Materials:

- made in metal with anti-scratch and sliding rubber base for collecting paper for disposal and ABS guide
- lead free enamel painting highly resisting wear and corrosion

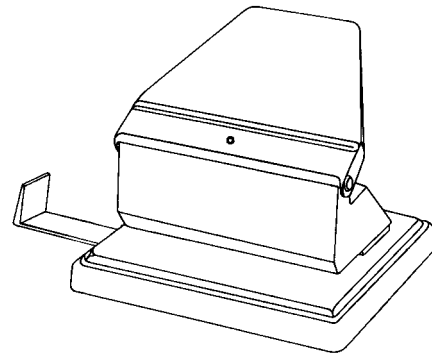

### Technical / functional features:

- **Distance between the two holes:** 70 or 80 mm

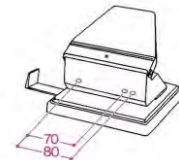

- |                                  |   |
|----------------------------------|---|
| • <b>Hole diameter:</b>          | 5,5 mm                                      |
| • <b>Punching capacity :</b>     | 15 sheets (80 g/mq)                         |
| • <b>Colours:</b>                | BLACK - GREEN                               |
| • <b>Guide:</b>                  | in ABS, <u>supplied with the perforator</u> |
| • <b>Weight:</b>                 | 625 g (net) / 680 g(gross)                  |
| • <b>Box dimensions:</b>         | 12,7 x 11,5 x 10,7 cm                       |
| • <b>N° of items per carton:</b> | 30 (packets of 3 pieces)                    |
| • <b>Carton dimensions:</b>      | 47,5 x 38 x 39,5 cm (AxBxC)                 |
| • <b>Carton weight:</b>          | 21,5 Kg                                     |

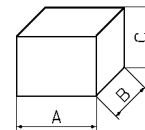

### Descriptive notes:

"ZENITH" 787 is a strong and practical perforator and with the slightest effort it makes perfect holes (diameter 5,5 mm) positioned 70 or 80 mm between each other, at user's discretion.

**Quality:** to maintain the high quality standard guaranteed by all "ZENITH" products, each perforator is tested piece by piece. ***Life-Guarantee for manufacturing defects.***

**In addition:** it is possible to use "ZENITH" 787 with little effort for up to 15 sheets because of its punches which are made in drawn and ground steel; also, the guide and cutter holes are ground with perfect gauging. Paper positioning is easier thanks to the practical ABS guide, standard supplied.

# "ZENITH" 788

## PERFORATOR

### Materials:

- made in metal with anti-scratch and sliding rubber base for collecting paper for disposal and ABS guide
- lead free enamel painting highly resisting wear and corrosion

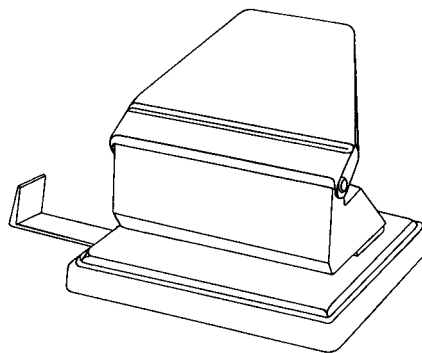

### Technical / functional features:

- **Distance between the two holes:** 80 mm



- |                                  |   |
|----------------------------------|---|
| • <b>Hole diameter:</b>          | 5,5 mm                                      |
| • <b>Punching capacity :</b>     | 15 sheets (80 g/mq)                         |
| • <b>Colour:</b>                 | ALUMINIUM                                   |
| • <b>Guide:</b>                  | in ABS, <u>supplied with the perforator</u> |
| • <b>Weight:</b>                 | 610 g (net) / 665 g(gross)                  |
| • <b>Box dimensions:</b>         | 12,7 x 11,5 x 10,3 cm                       |
| • <b>N° of items per carton:</b> | 30 (packets of 3 pieces)                    |
| • <b>Carton dimensions:</b>      | 47,5 x 38 x 39,5 cm (AxBxC)                 |
| • <b>Carton weight:</b>          | 21 Kg                                       |

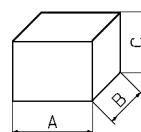

### Descriptive notes:

"ZENITH" 788 is a practical perforator with strong construction and effortless working. The only difference from the "ZENITH" 787 is the distance between the holes of 80 mm.

**Quality:** to maintain the high quality standard guaranteed by all "ZENITH" products, each perforator is tested piece by piece. ***Life-Guarantee for manufacturing defects.***

**In addition:** it is possible to use "ZENITH" 788 with little effort for up to 15 sheets because of its punches which are made in drawn and ground steel; also, the guide and cutter holes are ground with perfect gauging to ensure the best precision. By positioning the standard supplied adjustable guide in 3 ways, it is possible to make:

- 2 or 4 holes centred on the long side of the sheet UNI A4 size (210x297 mm)
- 2 holes centred on the short side of the sheet UNI A5 size (210x148 mm).

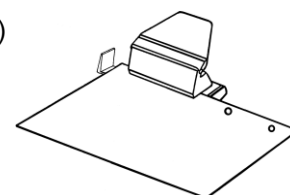

# "ZENITH" 888 PERFORATOR

## Materials:

- made in metal with base for collecting paper and guide in ABS anti-shock
- lead free enamel painting highly resisting wear and corrosion

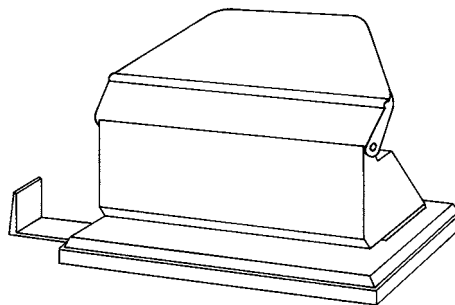

## Technical / functional features:

- **Distance between the two holes:** 80 mm

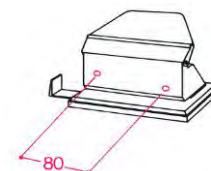

- |                                  |   |
|----------------------------------|---|
| • <b>Hole diameter:</b>          | 5,5 mm                                      |
| • <b>Punching capacity :</b>     | 10 sheets (80 g/mq)                         |
| • <b>Colour:</b>                 | ALUMINIUM                                   |
| • <b>Guide:</b>                  | in ABS, <u>supplied with the perforator</u> |
| • <b>Weight:</b>                 | 305 g (net) / 340 g (gross)                 |
| • <b>Box dimensions:</b>         | 12 x 8,2 x 8,2 cm                           |
| • <b>N° of items per carton:</b> | 60 (packets of 3 pieces)                    |
| • <b>Carton dimensions:</b>      | 47x 38 x 35 cm (AxBxC)                      |
| • <b>Carton weight:</b>          | 21,5 Kg                                     |

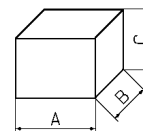

## Descriptive notes:

"ZENITH" 888 is a smaller but equally strong version of the range of "ZENITH" perforators. It has an ABS guide for quick and exact positioning of the sheets; it is practical, handy and also offers effortless working. In fact, with the slightest effort it is possible to make perfect holes (diameter 5,5 mm) positioned 80 mm between each other.

**Quality:** to maintain the high quality standard guaranteed by all "ZENITH" products, each perforator is tested piece by piece. ***Life-Guarantee for manufacturing defects.***

**In addition:** precision is ensured by the punches which are in drawn and ground steel.

By positioning the adjustable guide in 3 ways, it is possible to make:

- 2 or 4 holes centred on the long side of the sheet UNI A4 size (210x297 mm)
- 2 holes centred on the short side of the sheet UNI A5 size (210x148 mm).

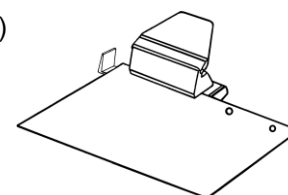

# "ZENITH" 835

## PAPER DRILL

### Materials:

- made in ABS plastic
- hollow punches in hardened steel

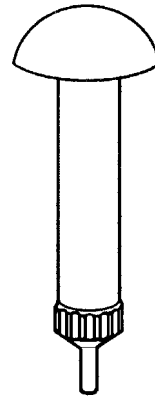

### Technical / functional features:

#### Hole diameter and punching capacity (mm)

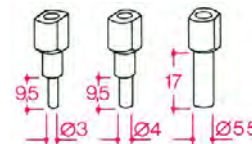

**Available hollow punches:**

3 (at customer's choice)

**Colour:**

BLACK / GREY

**Weight:**

36 g (net) / 55 g (gross, including three assorted hollow punches)

**Box dimensions:**

6 x 4,8 x 12,2 cm

**N° of items per packet:**

10

### Descriptive notes:

"ZENITH" 835 paper drill can perforate accurately and quickly paper, cloths, rubber, leather, etc. from 9,5 to 17 mm in thickness, based on the diameter of the hollow punches.

These are in hardened steel and can make holes of 3 - 4 - 5,5 mm diameter.

"ZENITH" paper drill is also available with one punch (**ref.833**); two punches (**ref.834**) or without punches (**ref.836**).

The hollow punches are supplied in the following possible packaging:

- **ref.850/bis:** box of 12 pieces, assorted in the three sizes or all of the same size requested by the customer.
- **ref. 850 Ø 3:** transparent plastic shell containing only one hollow punch diam. mm. 3
- **ref. 850 Ø 4:** transparent plastic shell containing only one hollow punch diam. mm. 4
- **ref. 850 Ø 5,5:** transparent plastic shell containing only one hollow punch diam. mm. 5,5

**Using the drill:** lay its point vertically on the surface you wish to perforate and press turning the drill in both directions.

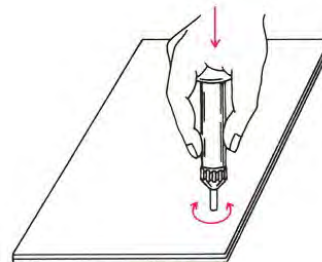

# "ZENITH" 820

## PEN HOLDER

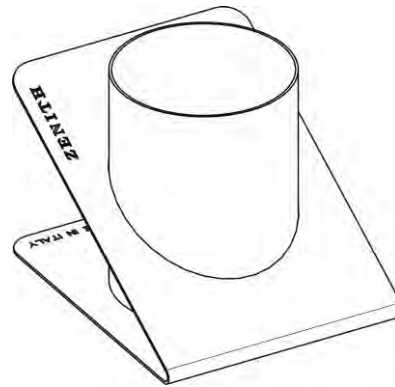

### Materials:

- base made in painted metal, lead free enamel painting highly resisting wear and corrosion
- nickel-plated pen holder cylinder
- supplied with a base protecting disc



### Technical / functional features:

<b>Pen holder cylinder:</b>	Ø (internal) 67 mm
<b>Colour:</b>	BLACK - WHITE - RED BORDEAUX - BLUE
<b>Weight:</b>	490 g (net) / 517 g (gross)
<b>Box dimensions:</b>	12,2 x 10 x 9,2 cm
<b>N° of items per carton:</b>	12 (packets of 4 pieces)
<b>Carton dimensions:</b>	45 x 29 x 21 cm (AxBxC)
<b>Carton weight:</b>	7 Kg

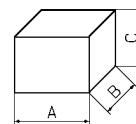

### Descriptive notes:

The new "ZENITH" pen holder ref. 820 is an object with a unique and special design, characterised by simple and essential lines, whose innovative shape is protected at patent level as a Utility Model.

It consists of two components made entirely in metal, with a nickel-plated pen holder cylinder and a base painted in the four available colours: red bordeaux, blue, black and white.

**Quality:** Life-guarantee for manufacturing defects.

**In addition:** unlike the other pen holders currently in use, generally consisting of a single piece (glass) to be placed on the desk, and mostly devoid of the necessary stability in case of accidental impacts, the ZENITH 820 pen holder guarantees absolute stability in every situation, given by the size and strength of the base where the pen holder cylinder is inserted.

Even the packaging is particularly accurate in the graphics, presenting the product at its best in its different colours.

# "ZENITH" 821

## MAGNETIC CLIP HOLDER



### Materials:

- base made in painted metal, lead free enamel painting highly resisting wear and corrosion
- clip holder cylinder in drawn, nickel-plated and polished steel
- supplied with a magnetic rubber base

### Technical / functional features:

<b>Clip holder cylinder:</b>	Ø (internal) 67 mm
<b>Colour:</b>	BLACK - WHITE - BURGUNDY RED - BLUE
<b>Weight:</b>	202 g (net) / 220 g (gross, including No. 10 "ZENITH" corner clips ref. 815)
<b>Packaging:</b>	box containing a clip holder and No. 10 "ZENITH" corner clips ref. 815
<b>Box dimensions:</b>	cm 7,8 x 7,8 x 6,3 cm
<b>N° of items per carton:</b>	12 (packets of 4 pieces)
<b>Carton dimensions:</b>	33 x 18 x 17 cm (AxBxC)
<b>Carton weight:</b>	3,1 Kg

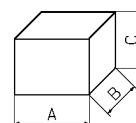

### Descriptive notes:

The new "ZENITH" clip holder ref. 821 is an object with a unique and special design, characterised by simple, essential and original lines. It consists of two components made entirely in metal, with a nickel-plated clip holder cylinder and a base painted in the four available colours: burgundy red, blue, black and white.

**Quality:** Life-guarantee for manufacturing defects.

### In addition:

The clip holders are supplied with a "magnetic" rubber base. Even the packaging is particularly accurate in its graphics, presenting the product at its best in its different colours.



# "ZENITH" 825

## DESK LETTER HOLDER

### Materials:

- Made of metal, with lead-free enamel painting highly resisting wear and corrosion



### Technical / functional features:

**Colour:** BLACK - WHITE - BURGUNDY RED - BLUE

**Weight:** 222 g (net) / 232 g (gross)

**Box dimensions:** cm 21 x 7,8 x 4,3

**N° of items per carton:** 12 (packets of 4 pieces)

**Carton dimensions:** 34 x 29 x 21 cm (AxBxC)

**Carton weight:** 3,4 Kg

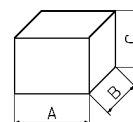

### Descriptive notes:

The new "ZENITH" desk letter holder ref. 825 is an object with an original design, characterized by simple and essential lines, ideal for managing correspondence in the best possible way.

Made entirely of metal, particularly stable, it is available in four colours: burgundy red, blue, black and white

**Quality:** Life-guarantee for manufacturing defects.

### In addition:

Even the packaging is particularly accurate in its graphics, presenting the product at its best in its different colours.



# "ZENITH" 830

## LETTER TRAY

### Materials:

- Support made of nickel-plated metal
- Trays made of metal, with lead-free enamels painting highly resisting wear and corrosion

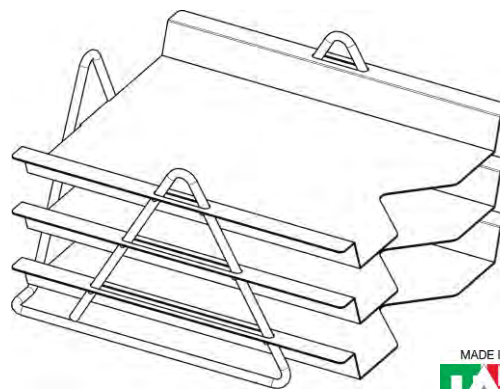

### Technical / functional features:

<b>Letter trays:</b>	No. 3, one above the other
<b>Trays dimensions:</b>	for A4 sheets up to cm 23 x 32
<b>Colour:</b>	BLACK - WHITE
<b>Weight:</b>	4445 g (net) / 4850 g (gross)
<b>Box dimensions:</b>	29 x 33 x 19,5 cm
<b>N° of items per carton:</b>	1
<b>Carton dimensions:</b>	38 x 32,5 x 24 cm (AxBxC)
<b>Carton weight:</b>	5,6 Kg

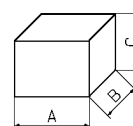

### Descriptive notes:

The "ZENITH" letter tray, whose innovative shape is protected by a utility model patent, combines the characteristics of sturdiness, functionality and design that have always distinguished "ZENITH" products.

**Quality:** Life-guarantee for manufacturing defects.

### In addition:

The particular shape of the nickel-plated support, made of a single piece, in addition to guaranteeing the stability of the trays, makes the letter tray an object with a refined design. The filing system with three metal compartments, equipped with a large central space, allows convenient access to documents.

# “COCCOINA” WHITE ADHESIVE PASTE



Item		Net/Gross Weight (g)	Pieces per box	Pieces per carton	Carton dimensions (AxBxC) (cm)	Carton weight (kg)
607 - 50 g	Plastic can with brush	50 / 70	20	240	48 x 30,5 x 35,5	18
608 - 125 g	Plastic can with brush	125 / 160	20	120	45,5 x 38 x 29,5	20
603 - 125 g	Aluminium can with brush	125 / 160	10	120	43,5 x 36 x 27	21
603/P - 125 g	Aluminium can with brush and coloured label	125 / 160	10	120	43,5 x 36 x 27	21
610 - 1000 g	Plastic can	1000 / 1080	-	18	41 x 38 x 27	21
615 - 5000 g	Plastic can	5000 / 5400	-	2	48 x 28,5 x 27	13

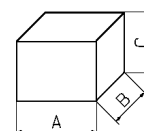

**Composition:** glue based on dextrine of potato flour in water (solvent free)

**Maintenance:** for longer usage, replace the cap tightly after each application. Maximum period of storage: not more than 12 months.

## Descriptive notes:

“Coccoina” white adhesive paste is available in the traditional and popular aluminium tins or in plastic cans, with brushes; both ensure preservation of the glue.

“Coccoina” paste is unique because of its almond fragrance and it glues paper, cloths, photos, labels... Easy to use and apply, it is ideal for children, because it is absolutely solvent free and harmless.

# “COCOINA” LIQUID GLUE

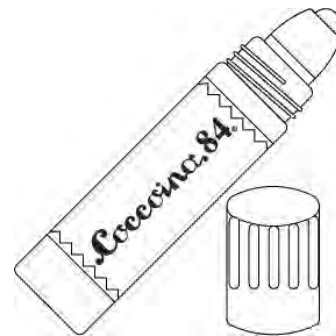

Item		Net/Gross weight (g)	Pieces per box	Pieces per carton	Carton dimensions (AxBxC) (cm)	Carton weight (kg)
688 - 25 g	Small plastic tube with rubber applicator	25 / 38	30	480	52,5x31x25,5	19,5
684 - 50 g	Small plastic tube with sponge applicator	50 / 70	20	240	38x32x29,5	18
681 - 100 g	Tube with sponge applicator	100 / 118	10	120	40x49,5x22	16,5
680 - 1000 g	Plastic bottle	1000 / 1100	-	10	37,5x19,5x25	12

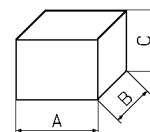

**Composition:** glue based on polyvinyl alcohol (solvent free)

**Maintenance:** after use, replace the cap tightly; if the cap is not completely sealed the glue applicator may become obstructed. However, this can easily be removed by rinsing the applicator with water.

## Descriptive notes:

“Coccoina” liquid glues have the traditional fragrance of the “Coccoina” glues and are suitable for gluing paper, thincards, cardboard, photos, cloths, etc.

The tubes of 25, 50 and 100 g are practical to use, very effective and easy to apply by pressing lightly on the tube. “Coccoina 81” ref. 681, in particular, is remarkable among the liquid glues range both for its size (100 g) and for its original and very functional sponge dispenser; furthermore each little tube may be easily hung as blister.

“Coccoina 81” ref.681 and “Coccoina 84” ref. 684 are suitable for applying glue on large surfaces.

On the other hand, “Coccoina 88” ref.688, with its rubber applicator, is perfect for accurately applying glue to well-defined and limited areas.

All the “Coccoina” liquid glues are suitable for office, home and school use because of their practical features.

The packagings are also practical and effective for desk displays, providing a better presentation of the product on the point of sale.

# LIQUID GLUE



Item		Net/Gross weight (g)	Pieces per packaging	Pieces per carton	Packaging dimensions (cm)	Carton dimensions (AxBxC) (cm)	Carton weight (kg)
685 – 50 g	Small tube with dispenser	50 / 60	12	240	155 x 155 x 55	57 x 32 x 23	16,5
685 A.A. <sup>(1)</sup> – 50 g	Small tube with dispenser	50 / 73	1	120	50 x 25 x 177 <sup>(2)</sup>	47 x 38 x 35	10

(1) Hangable cardboard case  
 (2) Height including buttonhole

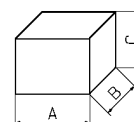

**Composition:** transparent glue based on polyvinyl alcohol (without solvents).

**Maintainance:** after use, replace the cap tightly.

## Descriptive notes:

e.Coccolina® is a strong, universal liquid glue for paper.

In addition to the traditional almond fragrance, e.Coccolina® stands out for its “Eco-friendly” contents:

New formula: **more than 80% natural components.**

Tube: realised with **more than 70% material of plant origin** (sugar cane). This special bio-based polyethylene, **certified “I’m green - BIO-BASED”** by ASTM, in replacement of fossil raw materials, significantly contributes to **reducing the overall greenhouse gas emissions** of the plastic chain.



## In addition:

The 12-piece pack and the one-piece hanging case **are made from 90% recycled cardboard, and FSC-certified.**



e.Coccolina® Enriches the already wide range of glues produced by Balma, Capoduri & C., which includes white adhesive paste, liquid glues, vinyl glues and glue sticks.

# “COCCOINA MIA” WHITE VINYL GLUE



Item		Net/Gross weight (g)	Pieces per packaging	Pieces per carton	Carton dimensions (AxBxC) (cm)	Carton weight (kg)
665 - 50 g	Small plastic tube with dispenser	50 / 60	12	240	57x31,5x21	16,5
668 - 25 g	Small coloured plastic tube with dispenser	25 / 30	30	120	43,5x43,5x27	5,4
660 - 1000 g	Plastic bottle	1000 / 1100	-	10	37,5x19,5x25	12

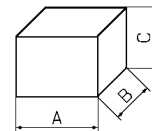

**Composition:** white vinyl glue based on polyvinyl acetate (solvent free)

**Maintenance:** replace the cap tightly, after use.

## Descriptive notes:

"Coccoina Mia", the white vinyl glue of "Coccoina" line, presents a new size: the brand new coloured little tubes of 25 g. (ref. 668) join the already innovative 50 g tube (ref. 665) and the 1000 g bottle (ref. 660).

They are supplied inside an original nice plastic ball display (dimensions cm. 20 x 20 x 25) containing 30 pcs., perfect for each point of sale, where the pocket size tubes in red, green and yellow are clearly visible.

"Coccoina Mia" is a white vinyl glue, non toxic, which maintains the traditional almond fragrance of all "Coccoina" glues; it is perfect to glue paper, wood, cloths, etc. and thanks to its little dimensions it is particularly fit for school, as it can be easily put into every pencil-case.

"Coccoina Mia" enriches the already wide range of "Coccoina" glues manufactured by Balma, Capoduri & C., which includes adhesive paste, liquid glues and stick glues.

# “COCCOINA” GLUE STICK



Item		Net/Gross weight (g)	Pieces per box/can	Pieces per carton	Carton dimensions (AxBxC) (cm)	Carton weight (kg)
641 - 10 g	display - box	10 / 22	30	480	46 x 29 x 20,5	11
642 - 20 g	display - box	20 / 39	20	360	36 x 29 x 32,5	15
642/9 - 20 g	decorated can	180 / 405	9	324 (36 cans)	46,5 x 37 x 38,5	16
644 - 40 g	display - box	40 / 65	10	120	40 x 33 x 17,5	9
649	desk display for “Coccoina” glue sticks 10g, 20g and 40g size	1590 / 3500	n.27 ref. 641 (10g) n.24 ref. 642 (20g) n.21 ref. 644 (40g)	1	27 x 22,5 x 51	5

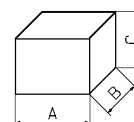

**Composition:** glue based on polyvinylpyrrolidone (solvent free) new formula

**Maintenance:** replace the cap tightly after use.

## Descriptive notes:

the “Coccoina” glues stick is available in **three sizes**, **10 g** (ref. 641), **20 g** (ref. 642) and **40 g** (ref. 644). It can easily and quickly glue paper, cardboard, photos, cloths, etc., either at home, school or in the office: “Coccoina” respects the environment because of the absence of solvents; it can be enjoyed by any type of end-user, adults and children at home, at school and in the office.

It is compact and easy to apply and can be removed by water.

**It also has the same traditional and recognizable fragrance of the “Coccoina” glues.**

The desk displays packaging, provide greater opportunities of selling because of their appealing graphics.

# CAN OF ASSORTED "COCCOINA" GLUES REF. 600/C



• Can dimensions:	Ø mm 133 x 260 h	
• Net/gross weight:	1190 g / 1910 g	
• No. of cans per carton:	5	
• Carton dimensions:	cm 35 x 36 x 29,5 (AxBxC)	
• Carton weight:	11,3 Kg.	

**Content:** The can combines tradition and modernity, in a perfect mix for the sales point. Each can contains the following assortment of glues:



No.4 Aluminium tins, with inside the original brush, containing "Coccoina" white adhesive paste ref. 603 - 125 g.



No.5 Tubes of "Coccoina" liquid glue with dispenser, ref. 684 – 50 g.



No.5 "Coccoina" glue sticks ref. 644 – 40 g.

No.12 "Coccoina" glue sticks ref. 642 – 20 g.

## Descriptive notes:

The can is made of thin cardboard with a very accurate graphics, made precious by seven of the most beautiful cards belonging to the history of "Coccoina" communication.

All "Coccoina" glues are solvent free, they can be washed with water and **they have the unique and traditional fragrance of "Coccoina" glues**, which is known by everybody.

They can answer the needs of each user at home, at school and in the office, and they stick easily and cleanly paper, cardboard, photos, cloths, labels, etc.



# "Coccoina" ref. 654

## SCENTED CANDLE



### Materials:

- Soy wax (55%) and Paraffin (45%);
- Cotton wick;
- Aluminum tin

### Specifications:

- **Burning time:** 16 hours (+/- 1 hour)
- **Fragrance:** bitter almond
- **Packaging:** box containing a candle
- **Box dimensions:** cm 9 x 9 x 7,4 h
- **Weight:** 90 g (net) / 147,50 g (gross)
- **N° of items per carton:** 36 (packets of 3 pieces)
- **Carton dimensions:** cm 57 x 32 x 23 h (AxBxC)
- **Carton weight:** 6,50 Kg.
- **Barcode:** 8009613654008
- **Carton barcode:** 8009613654367

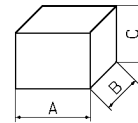

### How to use and warnings:

Do not burn candle on or near anything delicate.

### Safety Information:



### Descriptive notes:

"Coccoina" is now also an almond scented candle, with the same unmistakable fragrance that has always characterized "Coccoina" glues, in the same iconic aluminum tin of the famous adhesive paste (90 g content).

Made in Italy, like all "Coccoina" products, it has an excellent quality for all its components (wax and wick), with a burning duration of approximately 16 hours.

The packaging is also particularly refined, with a blue background label which almost faithfully recalls the one of the glue tin, while the cardboard package, containing one tin, best presents the contents with nice, linear and appealing graphics.

# “COCCOINA” PAPER PRODUCTS – Vintage Line

Covers made in embossed ivory paper with vintage pictures, internal pages in ivory paper (85 g/sqm) with almond fragrance.



Ref.		Size	No. of pages	Weight (g)	Pcs. per packing
672	notepad	A5 (148x210 mm)	50	163	5
673	notepad	A4 (210x297 mm)	50	325	5
674	soft cover notebook with rounded edges	A6 (105x148 mm)	32	50	5
676	hard cover ruled notebook with elastic closure	A6 (105x148 mm)	96	165	5
678	soft cover wirebound ruled notebook with elastic closure	A5 (148x210 mm)	64	245	5

Each article is packaged in a transparent envelope, labelled with description and barcode. The packages of 5 pcs. are wrapped in personalised "Coccoina" paper band.

## Desk display:

Ref.	Dimensions cm	Pcs. per box	Contents
670	31,5 x 33,5 x 29,5	1	No.4 • ref. 672, No.4 • ref. 673 No.4 • ref. 674, No.4 • ref. 676, No.4 • ref. 678 No.4 • ref. 603 ("Coccoina" glue in aluminium tin)

## Descriptive notes:

The Vintage line of "Coccoina" paper products, which includes different sizes of notepads and notebooks, is finely crafted with high quality standards. The covers show beautiful and rare ancient pictures of the old famous "Coccoina" advertising campaigns, all in an elegant vintage style, while the internal pages are imbued with the traditional almond fragrance of all "Coccoina" glues.

In order to help the introduction and visibility of the products in the points of sale a new desk display has been realized, with a pleasant and simple design, which contains four pcs. of each article in addition to four aluminium tins of "Coccoina" adhesive paste.

This initiative, which was presented as a preview at Paperworld 2015 in Frankfurt, is no doubt a means to strengthen "Coccoina" trademark on stationery market, with articles which fit well with the wide and well-known range of glues for home, school and the office.

# “COCCOINA” PAPER PRODUCTS – Pastel line

Covers in plain cardboard with pastel colours, internal pages in ivory paper (85 g/sqm) with almond fragrance.



Ref.		Size	No. of pages	Weight (g)	Pcs. per packing
671/P	pastel ruled wirebounded notepad	A6 (105x148 mm)	50	80	4
672/P	pastel ruled wirebounded notepad	A5 (148x210 mm)	50	162	4
674/P	pastel softcover stitched notebook	A6 (105x148 mm)	32	53	4
678/P	pastel softcover stitched notebook	A5 (148x210 mm)	32	106	4

Each article is packaged in a transparent envelope, labelled with description and barcode. The packages of 4 pcs. are wrapped in personalised "Coccoina" paper band.

## Desk display:

Ref.	Dimensions cm	Pcs. per box	Contents
670/P	31,5 x 33,5 x 29,5	1	n.4 · art. 671/P, n.4 · art. 672/P n.4 · art. 674/P, n.4 · art. 678/P n.8 · art. 603/P (Coccoina glue in aluminium tin)

## Descriptive notes:

After the success of the first line of paper products in "Vintage" style, with beautiful and rare ancient pictures of old "Coccoina" advertising campaigns, here comes a new assortment characterized by covers in four modern Pastel colours. The new "Pastel" line includes two ruled wirebounded notepads, in A5 and A6 sizes, and two softcover notebooks elegantly stitched, still in A5 and A6 sizes. All the covers are decorated with an embossed trimming which recalls the original one on the label of "Coccoina" aluminium tin... while the internal pages, in ivory paper of 85 g/sqm, are imbued with the characteristic almond fragrance of all "Coccoina" glues. Each article is packaged in a single transparent envelope, labelled with description and barcode. The packaging is also particularly accurate, with personalised "Coccoina" paper bands. In order to enhance the visibility of the products in the points of sale, a new counter display has also been realized, with a pleasant and simple design, which contains four pcs. of each article in addition to four aluminium tins of "Coccoina" adhesive paste. The aluminium tins supplied with the display (but also available in their display boxes of 10 pcs.) have something new (ref. 603/P): the labels are also in the same Pastel colours of the notepads and notebooks they come with, for a pleasant colour matching!

# "ZENITH" products: blister packaging



Item		Net/Gross weight (g)	Pieces per blister	Blister per packet (*)	Blister per carton	Blister dimensions (cm)	Carton dimensions (cm)	Carton weight (kg)
501 Shell	Desk-stapler	259/352	1	3	60	21x13,5x4,5	47x38x46	23
548/E	Plier-stapler	240/285	1	5	60	13,5x24,5	52x44x19,5	19
548/E Pastel	Plier-stapler	240/285	1	5	60	13,5x24,5	52x44x19,5	19
548/E Antibacterial	Plier-stapler	240/285	1	5	60	13,5x24,5	52x44x19,5	19
548/E Shell	Plier-stapler	240/300	1	5	60	21x13,5x2,5	48x30x35,5	19,5
590 (590 FUN)	Plier-stapler	187/233	1	5	60	13,5x24,5	52x44x22	14,5
590 Shell (590 FUN Shell)	Plier-stapler	187/252	1	5	60	21x13,5x2,5	48x30x35,5	16
591 (591 FUN)	Plier-stapler	192/245	1	5	80	13,5x24,5	66,5x31x41	21,5
591 Shell (591 FUN Shell)	Plier-stapler	192/260	1	5	60	21x13,5x2,5	48x30x35,5	16,5
130/E B4	Wire staples	76/98	4	10	250	9x15	48x21x35,5	25
130/E B8	Wire staples	152/192	8	5	125	13,5x24,5	50x40,5x30,5	25
595	Plier-stapler	313/410	1	5	30	15x26	48x28,5x27	13
515	Wire staples	102/124	2	10	150	9x15	48x21x35,5	19,5
580	Staple-remover	78/88	1	10	100	9x24,5	47x30,5x20,5	10
586	Staple-remover	26/39	1	10	100	9x15	52x44x22	5
815	Corner clips	28/48	1	6	96	14x9	43,5x36x27	5

(\*) Each packet contains the indicated number of items wrapped in a small band of polythene paper.

Technical / functional features of each item are listed in the relevant product-sheet.

**Notes:** all "ZENITH" blister packaged products are provided with bar code and QR code

**In addition:** features such as strength, clear design and detailed directions, as well as the "ZENITH" trademark, provide an opportunity for a practical and effective display of all "ZENITH" blister products at any point of sale. The "Shell" packaging (bivalve blister in PET shell type) can be hung either vertically or horizontally, moreover they have a small base which allows them to be supported on a plane for a useful display.

# "COCCOINA" products: blister packaging



Item		Net/Gross weight (g)	Pieces per blister	Blisters per packet	Blisters per carton	Blister dimensions (cm)	Carton dimensions (cm)	Carton weight (kg)
684	"Coccoina 84" Liquid glue tube 50 g	50/80	1	6(*)	180	9 x 20	50x40,5x30,5	15,5
641	"Coccoina" Stick 10 g	10/32	1	6(*)	180	9 x 20	50x40,5x30,5	7
641 B/3	"Coccoina" Stick 10 g	30/73	3	6(*)	180	9 x 20	50x40,5x30,5	14
642	"Coccoina" Stick 20 g	20/49	1	6(*)	180	9 x 20	50x40,5x30,5	10
642 B/2	"Coccoina" Stick 20 g	40/85	2	6(*)	120	9 x 20	48x27x35,5	11,5
642 SP/3-S	"Coccoina" Stick 20 g with free sample (**)	60/138	3	12(***)	24	25,8 x 15,2	35x36x29,5	4,8
644	"Coccoina" Stick 40 g	40/75	1	6(*)	120	9 x 20	45,5x38x29,5	11
665	"Coccoina Mia" White vinyl glue tube 50 g	50/73	1	6(*)	120	9 x 20	52x44x22	10
668 B/3	Coloured tubes "Coccoina Mia" White vinyl glue 25 g	75/110	3(****)	6(*)	120	12 x 20	66x31x40	14

(\*) Each packet contains the indicated number of items wrapped in a small band of polythene paper.

(\*\*) Each skin-pack contains 3 x 20g sticks and a useful instrument for drawing, among: a 180° protractor, a 20 cm ruler, or a miter square.

(\*\*\*) This packet is a display-box in cardboard.

(\*\*\*\*) Assorted tubes in red, green and yellow colors.

Technical / functional features of each item are listed in the relevant product-sheet.

**Notes:** all blister packaged products are provided with bar code and QR code.

**In addition:** features such as strength, clear design, as well as the blue "Coccoina" trade-mark, provide an opportunity for a practical and effective display of all "Coccoina" blister products at any point of sale.

## BAR CODES

Article	Colour	Packing	Code
<b>"ZENITH" DESK STAPLERS</b>			
501	Black	box	8009613501005
	Red	box	8009613501012
	Green	box	8009613501029
	Red transp.	box	8009613501036
	Blue transp.	box	8009613501043
	Yellow transp.	box	8009613501050
	assorted colours	Master carton with 60 staplers ref. 501	8009613501609
501 shell		shell	8009613501104
	assorted colours	Master carton with 60 staplers ref. 501 shell	8009613501616
501/E	Black	box	8009613501401
		Master carton with 60 staplers ref. 501/E	8009613501623
500	Black	box	8009613500008
	Grey	box	8009613500671
	assorted colours	Master carton with 60 staplers ref. 500	8009613500602
520/E	Aluminium	box	8009613520105
		Master carton with 60 staplers ref. 520/E	8009613520600
520 GOLD	Black	box	8009613520303
	Red	box	8009613520310
502	Black	box	8009613502002
	Grey	box	8009613502675
	assorted colours	Master carton with 30 staplers ref. 502	8009613502309
522/E	Aluminium	box	8009613522109
		Master carton with 30 staplers ref. 522/E	8009613522307
578	Black	box	8009613578007
	Grey	box	8009613578670
	assorted colours	Master carton with 30 staplers ref. 578	8009613578304
506	Black	box	8009613506000
		Master carton with 30 staplers ref. 506	8009613506307
<b>"ZENITH" PLIER STAPLERS</b>			
548 GOLD	Red	box	8009613548307
	Black	box	8009613548390
548	Black	box	8009613548000
	Burgundy red	box	8009613548031
	Blue	box	8009613548048
	White	box	8009613548055
	assorted colours	Master carton with 60 staplers ref. 548	8009613548611

**BAR CODES**

<b>Article</b>	<b>Colour</b>	<b>Packing</b>	<b>Code</b>
<b>"ZENITH" PLIER STAPLERS</b>			
548/E2	Aluminium	box Master carton with 60 staplers ref. 548/E2	8009613548208 8009613548659
548/E	Blue/pale blue	box	8009613548079
	Grey	box	8009613548109
	Green/black	box	8009613548352
	White/black	box	8009613548369
	Red/black	box	8009613548437
	Aluminium	box	8009613548475
548/E CW	Pale blue/White	Master carton with 60 staplers ref. 548/E CW	8009613485121
548/E	assorted colours	Master carton with 60 staplers ref. 548/E	8009613548628
548/E TR	Tricolor Italian flag	box Master carton with 60 staplers ref. 548/E TR	8009613548314 8009613548727
548/E Replay 1948	Grey	box Master carton with 30 staplers ref. 548/E Replay 1948	8009613548482 8009613548765
548/E Pastel	Yellow	box	8009613548222
	Pink	box	8009613548239
	Light blue	box	8009613548246
	assorted colours	Master carton with 60 staplers ref. 548/E Pastel	8009613548734
548/E Pastel ESP 6		"ZENITH" desk display contains: n.6 "ZENITH" staplers ref. 548/E Pastel Master carton with 4 "ZENITH" desk display ref. 548/E Pastel ESP 6	8009613548253 8009613548741
548/E SIXTY		box Master carton with 60 staplers ref. 548/E SIXTY	8009613548017 8009613548949
548/E Antibacterial		box Master carton with 60 staplers ref. Antibacterial	8009613548062 8009613548963
548/E Jeans		box Master carton with 60 staplers ref. 548/E Jeans	8009613485022 8009613485114
548/E Century		box Master carton with 60 staplers ref. 548/E Century	8009613485046 8009613485077
548/E blister		blister Master carton with 60 staplers ref. 548/E blister	8009613548123 8009613548635
548/E Pastel blister	Light blue	blister Master carton with 60 blisters ref. 548/E Pastel blister	8009613548260 8009613548758



## BAR CODES

Article	Colour	Packing	Code
<b>"ZENITH" PLIER STAPLERS</b>			
548/E Antibacterial blister		blister	8009613485015
		Master carton with 60 blisters ref. 548/E Antibacterial blister	8009613485107
548/E shell		shell	8009613548505
		Master carton with 60 staplers ref. 548/E shell	8009613548642
590	Beige	box	8009613590009
	Grey/beige	box	8009613590719
	Red/beige	box	8009613590726
	Transp./Aluminium	box	8009613590740
	Black	box	8009613590757
	assorted colours	Master carton with 60 staplers ref. 590	8009613590603
590 blister	Beige	blister	8009613590023
	assorted colours	Master carton with 60 staplers ref. 590 blister	8009613590610
590 shell		shell	8009613590108
		Master carton with 60 staplers ref. 590 shell	8009613590627
590 FUN	Yellow tr./white	box	8009613590801
	Green tr./white	box	8009613590818
	Blue tr./white	box	8009613590825
	Violet tr./white	box	8009613590832
	Red tr./white	box	8009613590849
	assorted colours	Master carton with 60 staplers ref. 590 FUN	8009613590634
590 FUN blister		blister	8009613590900
	assorted colours	Master carton with 60 staplers ref. 590 FUN blister	8009613590641
590 FUN shell		shell	8009613590153
		Master carton with 60 staplers ref. 590 FUN shell	8009613590658
590 MET	Metallic red bordeaux	box	8009613590306
	Metallic blue	box	8009613590320
	Metallic green	box	8009613590313
	assorted colours	Master carton with 60 staplers ref. 590 MET	8009613590689
590 MIX		box	8009613590788
		Master carton with 60 staplers ref. 590 MIX	8009613590597

## BAR CODES

Article	Colour	Packing	Code
<b>"ZENITH" PLIER STAPLERS</b>			
590 TECH	WW	box	8009613590221
	AW	box	8009613590238
	BC	box	8009613590245
590 TECH ESP 6		Master carton with 60 staplers ref. 590 TECH	8009613590283
		"ZENITH" desk display contains: n.6 "ZENITH" staplers ref. 590 TECH	8009613590252
		Master carton with 4 "ZENITH" desk display ref. 590 TECH ESP 6	8009613590276
590 CRAFT		box	8009613590290
		Master carton with 60 staplers ref. 590 CRAFT	8009613590986
591	Beige	box	8009613591006
	Red/black	box	8009613591433
	Black	box	8009613591693
	Yellow/beige	box	8009613591730
	Transp./beige	box	8009613591747
	assorted colours	Master carton with 80 staplers ref. 591	8009613591518
591 blister	Beige	blister	8009613591020
	Red/black	blister	8009613591037
	Yellow/beige	blister	8009613591044
	Transp./beige	blister	8009613591051
	Black	blister	8009613591068
	assorted colours	Master carton with 80 staplers ref. 591 blister	8009613591525
591 shell		shell	8009613591105
		Master carton with 60 staplers ref. 591 shell	8009613591532
591 FUN	Red tr./white	box	8009613591808
	Green tr./white	box	8009613591815
	Yellow tr./white	box	8009613591822
	Blue tr./white	box	8009613591839
	Violet tr./white	box	8009613591846
	assorted colours	Master carton with 80 staplers ref. 591 FUN	8009613591549
591 FUN blister	Red tr./white	blister	8009613591907
	Green tr./white	blister	8009613591914
	Yellow tr./white	blister	8009613591921
	Blue tr./white	blister	8009613591938
	Violet tr./white	blister	8009613591945
	assorted colours	Master carton with 80 staplers ref. 591 FUN blister	8009613591556
591 FUN shell		shell	8009613591150
		Master carton with 60 staplers ref. 591 FUN shell	8009613591563

## BAR CODES

Article	Colour	Packing	Code
<b>"ZENITH" PLIER STAPLERS</b>			
551	Grey	box	8009613551000
	Aluminium	box	8009613551475
	assorted colours	Master carton with 30 staplers ref. 551	8009613551307
595	Black	box	8009613595004
	Red/beige	box	8009613595721
	assorted colours	Master carton with 30 staplers ref. 595	8009613595301
595 blister		blister	8009613595028
		Master carton with 30 staplers ref. 595 blister	8009613595318
<b>"ZENITH" STAPLE- REMOVERS</b>			
580		box	8009613580000
		Master carton with 240 staple-removers ref. 580	8009613580246
580 blister		blister	8009613580024
		Master carton with 100 staple-removers ref. 580 blister	8009613580109
580 GOLD		box	8009613580017
585		box	8009613585005
585 GOLD		box	8009613585302
586		box	8009613586002
		Master carton with 100 staple-removers ref. 586	8009613586101
586 blister		blister	8009613586026
		Master carton with 100 staple-removers ref. 586 blister	8009613586118
<b>"ZENITH" STAPLES</b>			
515		little box	8009613556012
		Master carton with 300 little boxes ref. 515	8009613556036
515 blister		blister with 2 little boxes	8009613554049
		Master carton with 150 blisters ref. 515 blister	8009613556159
515 bis		little box	8009613556050
		Master carton with 50 little boxes ref. 515 bis	8009613556500
515/8		little box	8009613558016
		Master carton with 300 little boxes ref. 515/8	8009613558030
515/8 bis		little box	8009613558054
		Master carton with 60 little boxes ref. 515/8 bis	8009613558603
515/10		little box	8009613551017
		Master carton with 300 little boxes ref. 515/10	8009613551031
115/Z		little box	8009613156410
		Master carton with 300 little boxes ref. 115/Z	8009613156304

## BAR CODES

Article	Colour	Packing	Code
<b>"ZENITH" STAPLES</b>			
115/Z 8		little box Master carton with 300 little boxes ref. 115/Z 8	8009613158414 8009613158308
115/LL		little box Master carton with 300 little boxes ref. 115/LL	8009613156212 8009613156236
115/8 LL		little box Master carton with 300 little boxes ref. 115/8 LL	8009613158216 8009613158315
115/LM		little box Master carton with 300 little boxes ref. 115/LM	8009613156311 8009613156328
512		little box Master carton with 100 little boxes ref. 512	8009613526053 8009613526107
512/8		little box Master carton with 100 little boxes ref. 512/8	8009613528057 8009613528101
512/LM		little box Master carton with 100 little boxes ref. 512/LM	8009613526350 8009613526114
512/8 LM		little box Master carton with 100 little boxes ref. 512/8 LM	8009613528354 8009613528118
112/Z		little box Master carton with 300 little boxes ref. 112/Z	8009613126468 8009613126307
112/LM		little box Master carton with 300 little boxes ref. 112/LM	8009613126369 8009613126314
130/Z		box (while stocks last) little box box with 10 little boxes ref. 130/Z Master carton with 1000 little boxes ref. 130/Z	80176350 8009613104411 8009613104428 8009613104107
130/Z bis		little box Master carton with 100 little boxes ref. 130/Z bis	8009613104459 8009613104114
130/E		little box box with 10 little boxes ref. 130/E Master carton with 1000 little boxes ref. 130/E	8009613130007 8009613104022 8009613104121
130/E B/4 blister		blister with 4 little boxes Master carton with 250 blisters ref. 130/E B/4 blister	8009613104046 8009613104251
130/E B/8 blister		blister with 8 little boxes Master carton with 125 blisters ref. 130/E B/8 blister	8009613104084 8009613104138
130/E bis		little box Master carton with 100 little boxes ref. 130/E bis	8009613104053 8009613104145

## BAR CODES

Article	Colour	Packing	Code
<b>"ZENITH" STAPLES</b>			
130/Z 6		box (while stocks last)	80176374
		little box	8009613106415
		box with 10 little boxes ref. 130/Z.6	8009613106422
		Master carton with 500 little boxes ref. 130/Z 6	8009613106507
130/Z 6 bis		little box	8009613106453
		Master carton with 100 little boxes ref. 130/Z 6 bis	8009613106101
130/LM		little box	80176343
		box with 10 little boxes ref. 130/LM	8009613104329
		Master carton with 500 little boxes ref. 130/LM	8009613104152
130/LM bis		little box	8009613104350
		Master carton with 100 little boxes ref. 130/LM bis	8009613104169
130/LL		little box	8009613130021
		box with 10 little boxes ref. 130/LL	8009613104220
		Master carton with 1000 little boxes ref. 130/LL	8009613104268
110		little box	80176329
		box with 10 little boxes	8009613114427
		Master carton with 600 little boxes ref. 110	8009613114601
<b>"ZENITH" PERFORATORS</b>			
787	Black	box	8009613787102
	Green	box	8009613787119
		Master carton with 30 perforators ref. 787	8009613787300
788	Aluminium	box	8009613788109
		Master carton with 30 perforators ref. 788	8009613788307
888	Aluminium	box	8009613888007
		Master carton with 60 perforators ref. 888	8009613888601
<b>"ZENITH" PAPER DRILLS</b>			
836		box without hollow punches	8009613836008
833		box 1 hollow punch diam. mm 3	8009613833311
		box 1 hollow punch diam. mm 4	8009613833410
		box 1 hollow punch diam. mm 5,5	8009613833519
834		box 2 hollow punches diam. mm 3	8009613834325
		box 2 hollow punches diam. mm 4	8009613834424
		box 2 hollow punches diam. mm 5,5	8009613834523
		box 2 hollow punches diam. mm 3-4	8009613834127
		box 2 hollow punches diam. mm 3-5,5	8009613834226
		box 2 hollow punches diam. mm 4-5,5	8009613834622

## BAR CODES

Article	Colour	Packing	Code
<b>"ZENITH" PAPER DRILLS</b>			
835		box 3 hollow punches diam. mm 3	8009613835339
		box 3 hollow punches diam. mm 4	8009613835438
		box 3 hollow punches diam. mm 5,5	8009613835537
		box 3 hollow punches diam. mm 3-4-5,5	8009613835735
<b>"ZENITH" HOLLOW PUNCHES FOR PAPER DRILL</b>			
850/BIS		box with 12 assorted hollow punches diam. 3 - 4 - 5,5 mm	8009613850004
		box with 12 hollow punches diam. 3 mm	8009613850301
		box with 12 hollow punches diam. 4 mm	8009613850400
		box with 12 hollow punches diam. 5,5 mm	8009613850509
850 - Ø 3		Transparent plastic shell with 1 hollow punch diam. mm. 3	8009613850318
850 - Ø 4		Transparent plastic shell with 1 hollow punch diam. mm. 4	8009613850417
850 - Ø 5,5		Transparent plastic shell with 1 hollow punch diam. mm. 5,5	8009613850516
<b>"ZENITH" CORNER CLIPS</b>			
815		box with 50 corner clips	8009613815058
		Master carton with 96 boxes ref. 815	8009613815065
815 blister		blister	8009613815027
		Master carton with 96 blisters ref. 815 blister	8009613815072
815 GOLD		box with 50 golden corner clips	8009613815089
		Master carton with 96 boxes ref. 815 Gold	8009613815096
<b>"ZENITH" PEN HOLDER</b>			
820	Burgundy red	box	8009613820038
	Blue	box	8009613820045
	White	box	8009613820021
	Black	box	8009613820014
		Master carton with 12 pen holder ref. 820	8009613820120
<b>"ZENITH" MAGNETIC CLIP HOLDER</b>			
821	Burgundy red	box	8009613821035
	Blue	box	8009613821042
	White	box	8009613821028
	Black	box	8009613821011
		Master carton with 12 clips holder ref. 821	8009613821127

**BAR CODES**

<b>Article</b>	<b>Colour</b>	<b>Packing</b>	<b>Code</b>
<b>"ZENITH" DESK LETTER HOLDER</b>			
825	Burgundy red	box	8009613825033
	Blue	box	8009613825040
	White	box	8009613825026
	Black	box	8009613825019
		Master carton with 12 letter holder ref. 825	8009613825125
<b>"ZENITH" LETTER TRAY</b>			
830	Black	box	8009613830006
	White	box	8009613830013



## BAR CODES

Article	Colour	Packing	Code
<b>"COCCOINA" WHITE ADHESIVE PASTE</b>			
607		little plastic can 50 g (while stocks last)	80176312
		little plastic can 50 g	8009613607004
		box with 20 little cans ref. 607 - 50 g	8009613607035
		Master carton with 240 little plastic cans ref. 607 - 50 g	8009613607240
608		little plastic can 125 g	8009613608001
		box with 20 little cans ref. 608 - 125 g	8009613608032
		Master carton with 120 little plastic cans ref. 608 - 125 g	8009613608124
603		little aluminium can 125 g	8009613603006
		box with 10 little cans ref. 603 - 125 g	8009613603013
		Master carton with 120 little aluminium cans ref. 603 - 125 g	8009613603600
603/P		aluminium tin 125 g with coloured label (4 Pastel colours)	80571872
		box with 10 aluminium tin with coloured label ref. 603/P - 125 g	8009613603112
		Master carton with 120 aluminium tin with coloured label ref. 603/P - 125 g	8009613603624
610		plastic can 1000 g	8009613610004
		Master carton with 18 plastic cans ref. 610 - 1000 g	8009613610189
615		plastic can 5000 g	8009613615009
		Master carton with 2 plastic cans ref. 615 - 5000 g	8009613615023
<b>"COCCOINA" LIQUID GLUE</b>			
688		little tube 25 g	80571858
		display-box with 30 little tubes ref. 688 - 25 g	8009613688027
		Master carton with 480 tubes ref. 688 - 25 g	8009613688485
684		little tube 50 g (while stocks last)	80571841
		little tube 50 g	8009613684005
		display-box with 20 little tubes ref. 684 - 50 g	8009613684036
		Master carton with 240 tubes ref. 684 - 50 g	8009613684258
684 blister		blister with 1 little tube ref. 684 - 50 g	8009613684043
		Master carton with 180 blisters ref. 684 blister	8009613684180
681		tube 100 g	8009613681004
		display-box with 10 tubes ref. 681 - 100 g	8009613681103
		Master carton with 120 tubes ref. 681 - 100 g	8009613681608
680		plastic bottle 1000 g	8009613680007
		Master carton with 10 plastic bottles ref. 680 - 1000 g	8009613680106

## BAR CODES

Article	Colour	Packing	Code
<b>"eCOCCOINA" LIQUID GLUE</b>			
685		little tube 50 g display-box with 12 tubes ref. 685 - 50 g Master carton with 240 tubes ref. 685 - 50 g	8009613685002 8009613685019 8009613685125
685 A. A.		blister with 1 tube ref. 685 - 50 g Master carton with 120 boxes ref. 665 A.A.	8009613685040 8009613685132
<b>"COCCOINA MIA" WHITE VINYL GLUE</b>			
665		little tube 50 g display-box with 12 tubes ref. 665 - 50 g Master carton with 240 tubes ref. 665 - 50 g	8009613665004 8009613665011 8009613665127
665 blister		blister with 1 tube ref. 665 - 50 g Master carton with 120 blisters ref. 665 blister	8009613665042 8009613665967
668		little tube 25 g display-box with 30 tubes ref. 668 - 25 g Master carton with 120 tubes ref. 668 - 25 g	8009613668005 8009613668029 8009613668227
668 B/3 blister		blister with 3 tubes ref. 668 - 25 g Master carton with 120 blisters ref. 668 B/3 blister	8009613668043 8009613668203
660		plastic bottle 1000 g Master carton with 10 plastic bottles ref. 660 - 1000 g	8009613660009 8009613660108
<b>"COCCOINA" GLUE STICK</b>			
641		stick 10 g display-box with 30 sticks ref. 641 - 10 g Master carton with 480 sticks ref. 641 - 10 g	80571810 8009613641022 8009613641480
641 blister		blister with 1 stick ref. 641 - 10 g Master carton with 180 blisters ref. 641 blister	8009613641039 8009613641183
641 B/3 blister		blister with 3 sticks ref. 641 - 10 g Master carton with 180 blisters ref. 641 B/3 blister	8009613641046 8009613641190
642		stick 20 g (while stocks last) stick 20 g display-box with 20 sticks ref. 642 - 20 g Master carton with 360 sticks ref. 642 - 20 g	80571827 8009613642005 8009613642333 8009613642401
642 blister		blister with 1 sticks ref. 642 - 20 g Master carton with 180 blisters ref. 642 blister	8009613642340 8009613642180
642 B/2 blister		blister with 2 sticks ref. 642 - 20 g Master carton with 120 blisters ref. 642 B/2 blister	8009613642364 8009613642128

**BAR CODES**

<b>Article</b>	<b>Colour</b>	<b>Packing</b>	<b>Code</b>
<b>"COCCOINA" GLUE STICK</b>			
642 SP/3-S		skin-pack with 3 sticks and a free sample. Each skin-pack contains 3 x 20g sticks and, free of charge, an useful drawing or school instrument, alternatively, a 20 cm ruler, a 45° square or a 180° protractor. display-box with 12 skin-pack ref. 642 SP/3-S Master carton with 24 skin-pack ref. 642 SP/3-S	8009613642371 8009613642395 8009613642241
642/9		tin with 9 sticks ref. 642 - 20 g Master carton with 36 tins ref. 642/9	8009613642098 8009613642012
644		Stick 40 g display-box with 10 sticks ref. 644 - 40 g Master carton with 120 sticks ref. 644 - 40 g	8009613644009 8009613644016 8009613644122
644 blister		blister with 1 sticks ref. 644 - 40 g Master carton with 120 blisters ref. 644 blister	8009613644047 8009613644139
649		Counter display for "Coccoina" sticks. Each display contains n. 27 sticks ref. 641, 10g, n. 24 sticks ref. 642, 20g, and n. 21 sticks ref. 644, 40g.	8009613649721

**BAR CODES**

<b>Article</b>	<b>Colour</b>	<b>Packing</b>	<b>Code</b>
<b>Miscellaneous "Coccoina" glues</b>			
600/C		Can of assorted "Coccoina" glues contains: No. 4 aluminium tins of white adhesive paste ref. 603 - 125 g, No. 5 tubes of liquid glue ref. 684 - 50 g, No. 5 glue sticks ref. 644 - 40 g, No. 12 glue sticks ref. 642 - 20 g	8009613600005
		Master carton with 5 can of assorted "Coccoina" glues ref. 600/C	8009613600500

*Palma, Capoduri & C. s.p.a.*

**BAR CODES**

<b>Article</b>	<b>Colour</b>	<b>Packing</b>	<b>Code</b>
<b>"COCCOINA" ALMOND SCENTED CANDLE</b>			
654		box	8009613654008
		Master carton with 36 candles ref. 654	8009613654367

## BAR CODES

Article	Colour	Packing	Code
<b>"COCCOINA" NOTEPADS - VINTAGE LINE</b>			
672		Bag	8009613672002
673		Bag	8009613673009
<b>"COCCOINA" NOTEBOOKS - VINTAGE LINE</b>			
674		Bag	8009613674006
676		Bag	8009613676000
678		Bag	8009613678004
<b>"COCCOINA" DESK DISPLAY - VINTAGE LINE</b>			
670		"Coccoina" desk display contains: n.4 ref. 603, n.4 ref. 672, n.4 ref. 673, n.4 ref. 674, n.4 ref. 676, n.4 ref. 678	8009613670039
<b>"COCCOINA" NOTEPADS - PASTEL LINE</b>			
671/P		Bag	8009613671012
672/P		Bag	8009613672019
<b>"COCCOINA" NOTEBOOKS - PASTEL LINE</b>			
678/P		Bag	8009613678011
674/P		Bag	8009613674013
<b>"COCCOINA" DESK DISPLAY - PASTEL LINE</b>			
670/P		"Coccoina" desk display contains: n.8 ref. 603/P, n.4 ref. 672/P, n.4 ref. 671/P, n.4 ref. 674/P, n.4 ref. 678/P	8009613670015